

2.0 GETTING STARTED



FIGURE 2.01

To help ensure a project starts on the right foot, in this section, Nudura has compiled some helpful tips to help guide your building design, contract documentation, basic structural analysis, layout and elevation planning, estimation techniques and formulae and finally requirements for a typical permit submission involving Nudura product as well as tips on pre-construction planning specific for a Nudura building site. Following these steps should help to avoid delays when submitting your documents for building permit approval, and start your project on its way to a smooth and efficient build.

The permit applicant (usually the contractor) is ultimately responsible for communicating with, and ensuring that, the building department has the required information to process and issue a permit for a proposed project.

2.1 DRAWING & CONTRACT DOCUMENT PREPARATIONS

A smooth permit submission starts with the project drawings. Whether the project is starting from scratch in planning for use of Nudura or you are converting a drawing set from conventional construction to Nudura, the building official will need to see sufficient documentation to corroborate that Nudura is being used on the project and how it is specified and detailed.

First, determine the size and scope of your proposed building design and prepare your drawing set (or contact a local draftsman or AutoCAD designer) to reflect the fact that the building is being constructed using Nudura Integrated Building Technology. Nudura's experience has shown that there is nothing that gets a Building Official more incensed than a contractor or designer attempting to substitute a building system or component on a set of plans or building site that has not been properly referenced or documented on the permit application documents. Here are a few guidelines on what to include that will help the Building Official be more accepting of the submission documents:

- (a) Notes on the basement floor plan, either stand alone or indicating by arrow, to the foundation wall:
 - The Form Unit Core Thickness proposed for the installation
 - The Horizontal Bar Diameter and required c/c spacing (per the Governing Code Data, Nudura Structural Data or Evaluation Report, usually 18" o/c (457 mm) or at floor levels and every other course at minimum if permitted by code)
 - The Vertical Bar Diameter and required c/c spacing (reference back to the design tables for the local region– below grade)
 - Indicate that the vertical steel will project 20" to 24" (500 mm to 600 mm) above the first pour to stub into the main level wall cavity
 - Indicate that footing dowels of minimum #4 (USA) or 10M (CAN) bar at a maximum of 24" (600 mm) o/c, or #5 (USA) or 15M (CAN) bar at a maximum 48" (1220 mm) along the footing centre line and project into the foundation wall above the footing a minimum of 8" (200 mm)
- (b) Notes on the main and any subsequent floor plan either stand alone or indicating by arrow to the exterior walls:
 - The Form Unit Core Thickness
 - The Horizontal Bar Diameter and required c/c spacing (usually 18" o/c (457 mm) or reference the tables for the local region or Evaluation Report)
 - The Vertical Bar Diameter and required c/c spacing (reference the tables for the local region or Evaluation Report)

- Indicate how the floors will be attached to the Nudura wall (rim joist bolts, ICF Connect etc) and attach any corroborating data from the manufacturer or applicable code for spacing of these attachments. If a second floor is required, indicate that the vertical steel will project between 20" and 24" (508 mm and 610 mm) above the first pour to stub into the 2nd level wall cavity
 - Indicate the roof truss sill anchor bolts diameter & spacing
- (c) For all floor plans (including foundation plan), indicate at each window the required specifications for the lintels intended to be installed. These will include:
- The number, and diameter of the bottom horizontal bars in the lintel
 - The stirrup end distance (SED - the distance in from the edge of the opening that the stirrups start). Refer the Building Official to the installation manual diagram or perhaps staple a copy to the drawings to show the lintel cross section
 - The stirrup spacing back to the jamb from the SED, (see the lintel table notes in appendix E)
 - The overall height of the lintel
 - Indicate on the plan with a dashed line (i.e. _____) the fact that the bottom and top horizontal steel of the lintel extends 24" (610 mm) beyond the edge of the openings
 - As an alternate to including the above notes at each window, a lintel schedule which the openings can be referenced to can be created, similar to a Window Schedule Layout. This method of notation is preferred

2.1.1 GUIDELINES FOR REINFORCING STEEL DESIGN AND PLACEMENT

In preparing drawings, the most important difference between typical poured concrete walls and Nudura walls is the fact that the walls are reinforced walls. Under most building codes, Nudura is classified as a "Flat Wall ICF System" meaning that it enables the creation of flat monolithic structural reinforced concrete walls contained within the form system.

HOW NUDURA STEEL PLACEMENT DIFFERS FROM CONVENTIONAL POURED WALL REINFORCEMENT DESIGN

In considering flat wall design using Nudura Insulated Concrete Forms, it is best to consider the wall in exactly the same manner as all performance based building codes do – it is simply a structurally reinforced monolithic flat concrete wall with insulation mounted to both sides of the poured wall.

1. **MINIMAL TIE WIRING.** Though selected details of steel tying may be required at custom column or beam installations or around openings, the primary assembly of steel occurs without the use of tie wiring. Instead, Nudura relies on features built into its web or cross tie design to enable the wall to be constructed by relying on the "Non-contact Lap Splice" method of reinforcing for both horizontal and vertical steel placement as is provided for under Section 12 of ACI 318 in the USA and CAN/CSA A23.1 and A23.3 in Canada. Under most code bodies all non-contact lap splices installed must be lapped a minimum lap splice length of 40 times the bar diameter. This falls under the applicable concrete codes for monolithic concrete walls which this distance is based on requirements for bundled bars laps in flexural members as per ACI 318 Section 7.6.6.4 and CAN/CSA A23.3 Section 7.4.2.3. In addition, the lapped bars must not be positioned greater than 1/5th of the lap splice length apart or any further apart than 6" (152 mm). (Section 12.14.2.3 of both ACI 318 & CSA A23.3).

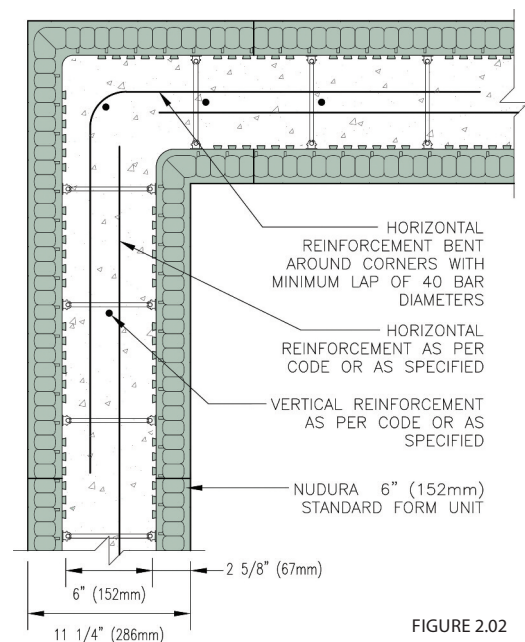

FIGURE 2.02

- ORDER OF STEEL PLACEMENT.** Unlike traditional forming, where the steel grid is cross wired together prior to the final form face being installed, Nudura wall reinforcing steel proceeds with placement of HORIZONTAL steel being laid in, in non-contact splice fashion, course by course as the form units (or blocks) are installed around the wall in bond stacking fashion. Corners and T form Wall connections, again, will normally feature non-contact lap splice connections (unless specific requirements of the design parameters for a local condition would dictate otherwise). VERTICAL steel placement then proceeds once coursing heights have reached either the top of each floor height of wall being installed (in multi-story installations) or (in the case of a staged single story tall height wall pour) at the designated termination drop height as dictated by the engineer (typically between 8' and 12' (2.4 m and 3.6 m in height). In these instances, the steel is cut by the installer to ensure a 40 times bar diameter non-contact lap splice with the level of floor being installed above it.
- NO TIE WIRING AT FOOTINGS.** Again, as adopted within most building codes, the footing dowels are in place to resist lateral movement at the base of the wall section through the installation of wet set dowels which extend from the footing into the base of the wall to be installed over it. The assembly order of the vertical steel requires that they be placed AFTER the wall is installed to full floor course height. This also dictates that there is NO requirement for the contractor/installer to provide tie wiring of the vertical steel to the footing (footer) dowels. Hence, a non-contact lap splice between the footing (footer) dowels and the wall steel is required at this junction.

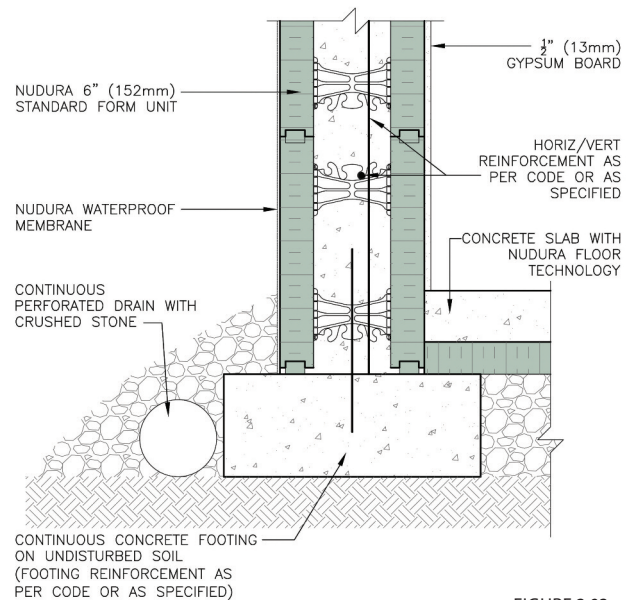

FIGURE 2.03

HORIZONTAL STEEL PLACEMENT METHOD

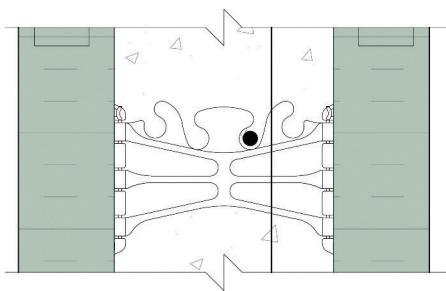

FIGURE 2.04

Nudura's unique web design allows the contractor/installer the ability to precisely locate reinforcing steel within the wall cavity, ensuring the rebar stays in the optimal required location, thus maximizing the strength of the complete concrete wall. (See Fig. 2.04) This is enabled by notches or capture lugs that are molded into the top and bottom of each cross tie connecting web, which allows the contractor/installer to accurately install the horizontal reinforcement bars within the concrete core in accordance with the Engineer's specifications. This eliminates the requirement of tie wiring the horizontal reinforcement bar in the correct location specified by the Engineer (in fact, enabling placement as close as $\frac{3}{4}$ " (19 mm) from the inside face of the form). This improves overall strength performance of the wall assembly which gives the design professional the comfort level of knowing the reinforcing steel has been cast in exact locations as specified.

NOTE: In the diagram (Fig. 2.04), for a 6" (152 mm) core form, there are 4 pairs of horizontal steel capture lugs per connection web, each of the lugs being positioned approximately $\frac{3}{4}$ " (19 mm) apart. This design feature is typical across the form line design for each cavity width of form available - with the wider forms providing more options for steel placement as space permits. The $\frac{3}{4}$ " (19 mm) gap is the secret to enabling vertical steel to be installed once course installations are completed (see Vertical Steel Placement Method under this Section).

HORIZONTAL STEEL SPECIFICATION TIPS

- Nudura forms are manufactured to a course height of 18" (457 mm). Therefore, for efficient on-site installation, always specify horizontal reinforcing at no denser a placement than 18" (457 mm) o/c. (Adjust vertical reinforcing density so that this 18" (457 mm) module can be maintained horizontally).
- If EXTRA horizontal reinforcement should be required (i.e. for higher seismic zones), consider moving to a higher diameter bar or – as a last resort, consider specifying placement of bar at the top AND bottom of a form unit.
- As per installation instruction, detailing would typically show the horizontal reinforcing oscillating from one lock position (of the pair of reinforcing steel cradles) to the other between horizontal lap splices. As installation proceeds up the wall, the installer will install the steel in the course immediately above in exact opposite positioning of the course below, in such a way that at every course (every 18" (457 mm)), horizontal bar will be capturing either one side of the vertical steel or the other as per positioning specification by the engineer (see Figure 2.05a).
- The placement of the horizontal steel can secure the vertical steel in the center and either the tension or compression side of the wall.
 - (a) Towards the tension (usually towards the "inside" of a below grade wall)
 - (b) Towards the outside (tension side) of a foundation wall containing back fill higher than the prevailing grade around it or if installed as a non-laterally supported retaining wall
 - (c) To the center of an above grade wall anticipating wind loading from multiple directions (as shown in Fig. 2.05b)

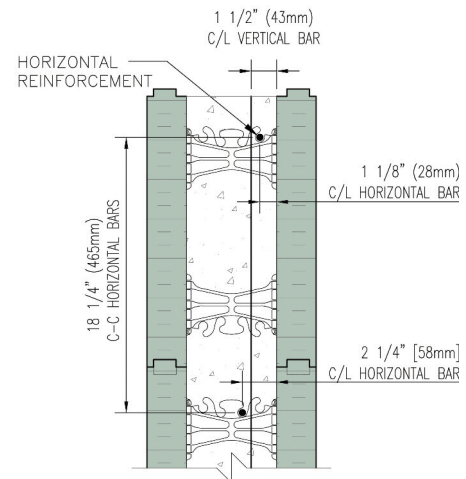

FIGURE 2.05a

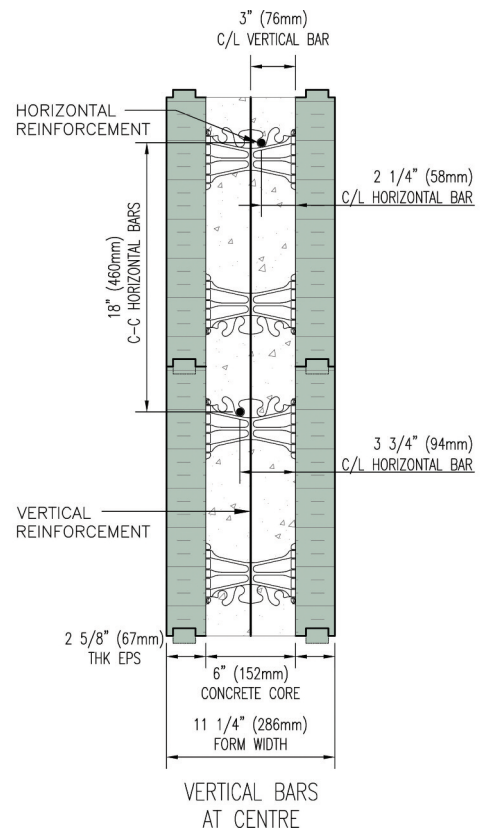

FIGURE 2.05b

VERTICAL STEEL PLACEMENT METHOD

Nudura's cross connecting web ties are preformed into the EPS panels at 8" (203 mm) o/c increments. To optimize vertical steel placement, a Nudura Trained Installer is instructed to do 3 things:

- (a) Ensure that the forms are placed with ALL webs being in vertical alignment with each other.
- (b) Feed vertical steel downward into the wall such that it will be WOVEN into the central $\frac{3}{4}$ " (19 mm) gap that is formed by the oscillating placement of the horizontal steel courses (as noted above)
- (c) Install vertical steel so that it occurs adjacent to a web on the side from which concrete is intended to be first placed into the wall. This means that as the concrete pushes against the vertical steel, the pressure of the concrete will drive the steel against the web and the web will prevent the vertical steel from moving out of alignment during the pour (hence, no tie wiring required)

By following the vertical steel specification tips given below, the design professional will guarantee that the installer will be able to best optimize accurate and rapid steel installation within the Nudura wall system.

VERTICAL STEEL SPECIFICATION TIPS

Using the above installer techniques as a guide, remember that reinforcing steel proceeds MOST efficiently if specified on vertical grids that are multiples of 8" (203 mm) on center. (i.e. 8, 16, 24, 32, 40, 48" (203, 406, 610, 813, 1016, 1219 mm) o/c).

If the design calculation requires vertical steel at increments not within the 8" (203mm) spacing of the web, Nudura recommends that the designer consider doubling every other reinforcement bar or to vary the bar diameter. This achieves the same required cross sectional area of steel in order to meet the design specifications.

When dealing with a cold joint, it is recommended to wet set dowels into the concrete as deep as 40 times the diameter of the reinforcement bar using a non contact lap splice. This will facilitate an easier in-field build than more traditional methods which require joint level access for tie wiring. Always remember that vertical steel is placed AFTER the wall is constructed to the designated construction height and prior to concrete placement.

2.1.2 HOW TO DESIGN WALLS AND LINTELS USING APPENDIX D AND E

Anyone already familiar with either the prescriptive methods employed in the design tables featured in either the USA International Residential Code (Section R404 and R611) or in NBC Codes 2005 and later under Section 9.17 and 9.20 can skip this information. However, if needed, you can always refer to this method if instructing someone new on how to use the Structural Design Tables contained in Appendix D and E of this manual.

Why use separate tables from Code Published Prescriptive Data? The Tables contained in Appendices D and E have been designed to conform to exactly the same concrete standards and limits as the IRC and NBC Code Tables conform to. However, Nudura's Engineers have designed these tables to ideally work with the specific geometry of the Nudura Form System (i.e. form unit heights of 18" (457 mm) and vertical web spacing at 8" (203 mm) on center and core thicknesses exactly matching the available form unit thicknesses of Nudura's form line-up).

IMPORTANT NOTES

1. Remember that the Design Tables have been based on the design methods adopted for prescriptive design for residential construction (single family residences, townhouse or one and two family homes) in either Canada or in the USA ONLY, and in conformance with the allowable limits under the applicable code sections or the applicable evaluation report for each country.

INSTALLATION MANUAL

- Similar to the majority of prescriptive data available in North America, Nudura's Structural Tables (Appendix D for Wall Design and E for Lintel Design) have been prepared basing design on 2 key elements:

Minimum Concrete Compressive Strength shall be: 3,000 lb/in² or 20 MPa

Minimum Yield Strength of Reinforcing Steel shall be: 60 kips/in² or 400 Grade

- Remember as well that the Engineers who have designed these tables have spelled out clear limitations to their use in the notes preceding the tables, limiting such things as maximum allowable live and dead loads, truss and floor span limits, roof slope, number of storeys above (maximum 2) and below (maximum 1) grade, even maximum allowable plan dimension, (in exact conformance with the prescriptive limits of the applicable Code). Nudura's engineers have assured that the selected design options will exceed the minimum reinforcement requirements for each country. However, please note that the designer/builder remains fully responsible for the CORRECT usage of these tables in applying the design parameters required to yield the final results.

BELOW GRADE WALL DESIGN = APPENDIX D

The designer needs to know 5 pieces of data:

- The desired core thickness that the client wishes to be used in the design (always start with 6" (152 mm)).
- The maximum height of the wall from the top surface of the footing to the underside of the floor joist connection to the wall.
- The height of backfill being placed against the wall. This is defined as the distance from the top of the basement floor slab to the maximum level of the backfill outside of the basement.
- The general type of soil condition anticipated for the site, whether it will be gravel/sand, sand loam mix, or clay or silt mix. The designer or builder should consider the worst case scenario if a combination of these soils is expected on site.
- The seismic zone classification for the site. (Depending on location this may or may NOT effect the design of below grade walls since backfill stresses tend to far outweigh seismic effects).

Below-Grade Walls Built with NUDURA Insulated Forms
Vertical and Horizontal Steel Reinforcement for Seismic Zone Classification: $S_1(0.2) \leq 0.12$

Wall Height m (ft)	Backfill Height m (ft)	Vertical Reinforcement						Horizontal Steel Reinforcement All Soils
		Free Draining Backfill Soil Type (Maximum Equivalent Fluid Density)						
		Sand & Gravel 480 kg/m ³ (30 pcf)			Sand, Gravel with Silt or Clay 720 kg/m ³ (45 pcf)			
		150 mm (6") Wall	200 mm (8") Wall	250 mm (10") Wall	150 mm (6") Wall	200 mm (8") Wall	250 mm (10") Wall	All Wall Thicknesses
2.44 (8.0)	1.22 (4.0)	See Note 2	See Note 2	See Note 2	See Note 2	See Note 2	See Note 2	10M @ 914 (36")
	1.53 (5.0)	See Note 2	See Note 2	See Note 2	10M @ 400 (16)	See Note 2	See Note 2	10M @ 914 (36")
	1.83 (6.0)	10M @ 400 (16)	See Note 2	See Note 2	15M @ 600 (24)	15M @ 600 (24)	15M @ 600 (24)	10M @ 914 (36")
	2.13 (7.0)	15M @ 400 (16)	See Note 2	See Note 2	15M @ 400 (16)	15M @ 400 (16)	See Note 2	10M @ 914 (36")
	2.44 (8.0)	15M @ 400 (16)	15M @ 400 (16)	15M @ 600 (24)	15M @ 400 (16)	15M @ 400 (16)	15M @ 400 (16)	10M @ 914 (36")
2.74 (9.0)	1.22 (4.0)	10M @ 400 (16)	10M @ 600 (24)	10M @ 800 (32)	10M @ 400 (16)	10M @ 600 (24)	10M @ 800 (32)	10M @ 914 (36")
	1.53 (5.0)	10M @ 400 (16)	10M @ 400 (16)	10M @ 600 (24)	10M @ 400 (16)	10M @ 400 (16)	10M @ 400 (16)	10M @ 914 (36")
	1.83 (6.0)	10M @ 400 (16)	15M @ 600 (24)	10M @ 400 (16)	15M @ 600 (24)	15M @ 600 (24)	15M @ 600 (24)	10M @ 914 (36")
	2.13 (7.0)	15M @ 400 (16)	15M @ 400 (16)	15M @ 600 (24)	15M @ 400 (16)	15M @ 400 (16)	15M @ 600 (24)	10M @ 914 (36")
	2.44 (8.0)	15M @ 400 (16)	15M @ 400 (16)	15M @ 600 (24)	15M @ 200 (8)	15M @ 400 (16)	15M @ 400 (16)	10M @ 914 (36")
3.05 (10.0)	1.22 (4.0)	10M @ 400 (16)	10M @ 600 (24)	10M @ 800 (32)	10M @ 400 (16)	10M @ 400 (16)	10M @ 600 (24)	10M @ 914 (36")
	1.53 (5.0)	10M @ 400 (16)	10M @ 400 (16)	10M @ 600 (24)	10M @ 400 (16)	15M @ 600 (24)	10M @ 400 (16)	10M @ 914 (36")
	1.83 (6.0)	10M @ 200 (8)	15M @ 600 (24)	10M @ 400 (16)	15M @ 400 (16)	15M @ 400 (16)	15M @ 600 (24)	10M @ 914 (36")
	2.13 (7.0)	15M @ 400 (16)	15M @ 400 (16)	15M @ 600 (24)	15M @ 400 (16)	15M @ 400 (16)	15M @ 400 (16)	10M @ 914 (36")
	2.44 (8.0)	15M @ 400 (16)	15M @ 400 (16)	15M @ 400 (16)	-	15M @ 400 (16)	15M @ 400 (16)	10M @ 914 (36")
3.35 (11.0)	1.22 (4.0)	10M @ 400 (16)	10M @ 600 (24)	10M @ 800 (32)	10M @ 400 (16)	10M @ 400 (16)	10M @ 600 (24)	10M @ 914 (36")
	1.53 (5.0)	10M @ 400 (16)	10M @ 400 (16)	10M @ 600 (24)	10M @ 400 (16)	15M @ 600 (24)	10M @ 400 (16)	10M @ 914 (36")
	1.83 (6.0)	15M @ 400 (16)	15M @ 600 (24)	10M @ 400 (16)	15M @ 400 (16)	15M @ 400 (16)	15M @ 600 (24)	10M @ 914 (36")
	2.13 (7.0)	15M @ 400 (16)	15M @ 400 (16)	15M @ 600 (24)	15M @ 200 (8)	15M @ 400 (16)	15M @ 400 (16)	10M @ 914 (36")
	2.44 (8.0)	15M @ 400 (16)	15M @ 400 (16)	15M @ 400 (16)	-	15M @ 400 (16)	15M @ 400 (16)	10M @ 914 (36")
3.66 (12.0)	1.22 (4.0)	-	15M @ 400 (16)	15M @ 400 (16)	-	15M @ 400 (16)	15M @ 400 (16)	10M @ 914 (36")
	1.53 (5.0)	-	15M @ 200 (8)	15M @ 400 (16)	-	15M @ 200 (8)	15M @ 400 (16)	10M @ 914 (36")
	1.83 (6.0)	15M @ 400 (16)	15M @ 400 (16)	15M @ 400 (16)	-	15M @ 400 (16)	15M @ 600 (24)	10M @ 914 (36")
	2.13 (7.0)	15M @ 400 (16)	15M @ 400 (16)	15M @ 600 (24)	15M @ 200 (8)	15M @ 400 (16)	15M @ 400 (16)	10M @ 914 (36")
	2.44 (8.0)	15M @ 200 (8)	15M @ 400 (16)	15M @ 400 (16)	-	15M @ 400 (16)	15M @ 400 (16)	10M @ 914 (36")
3.96 (13.0)	1.22 (4.0)	-	15M @ 400 (16)	15M @ 400 (16)	-	15M @ 200 (8)	15M @ 400 (16)	10M @ 914 (36")
	1.53 (5.0)	-	15M @ 200 (8)	15M @ 400 (16)	-	15M @ 200 (8)	15M @ 200 (8)	10M @ 914 (36")
	1.83 (6.0)	15M @ 400 (16)	15M @ 400 (16)	15M @ 400 (16)	-	15M @ 400 (16)	15M @ 600 (24)	10M @ 914 (36")
	2.13 (7.0)	15M @ 400 (16)	15M @ 400 (16)	15M @ 600 (24)	15M @ 200 (8)	15M @ 400 (16)	15M @ 400 (16)	10M @ 914 (36")
	2.44 (8.0)	15M @ 200 (8)	15M @ 400 (16)	15M @ 400 (16)	-	15M @ 400 (16)	15M @ 400 (16)	10M @ 914 (36")
4.26 (14.0)	1.22 (4.0)	-	15M @ 400 (16)	15M @ 400 (16)	-	15M @ 200 (8)	15M @ 400 (16)	10M @ 914 (36")
	1.53 (5.0)	-	15M @ 200 (8)	15M @ 400 (16)	-	15M @ 200 (8)	15M @ 200 (8)	10M @ 914 (36")
	1.83 (6.0)	15M @ 400 (16)	15M @ 400 (16)	15M @ 400 (16)	-	15M @ 400 (16)	15M @ 600 (24)	10M @ 914 (36")
	2.13 (7.0)	15M @ 400 (16)	15M @ 400 (16)	15M @ 600 (24)	15M @ 200 (8)	15M @ 400 (16)	15M @ 400 (16)	10M @ 914 (36")
	2.44 (8.0)	15M @ 200 (8)	15M @ 400 (16)	15M @ 400 (16)	-	15M @ 400 (16)	15M @ 400 (16)	10M @ 914 (36")

Note:
 1. This table is to be used in conjunction with "Design Limitations" prepared by Tacoma Engineers Inc.
 2. As per Part 9 of the National Building Code, for the wall and backfill height noted an unreinforced wall with $f_c = 20$ MPa is adequate.
 3. Refer to Design Limitations for info on construction methods, material specifications, design loads, additional wall reinforcement around openings, min. wall length, etc.
 4. 2-10M bars are permitted to replace each 15M bar at the specified spacing indicated above.

FIGURE 2.06

TABLE D.1 REINFORCEMENT FOR BELOW GRADE WALLS
Low Risk Seismic Class: Sa(0.2) ≤ 0.12
Sand/Gravel or Silty Sand/Clay Soils

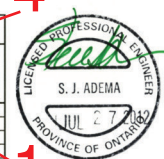

PROCEDURE

1. Knowing above information, from the Below Grade Design Tables select the correct design table from the options available (based on desired core thickness (6, 8 or 10" (152, 203, or 254 mm)) and seismic risk (Low or High).
2. Once the table has been selected, from the 2 left hand columns of the table, identify the required wall height and backfill height for each wall condition.
3. Next select the appropriate set of columns corresponding to the prevailing soil type at your site.
4. Note the required reinforcement for the condition at the corresponding cell to your required backfill height and desired core thickness of concrete. If there is NO notation, it means that you must select a higher core thickness of concrete.
5. If after repeating the scenario for both 8" (203 mm) and 10" (254 mm) core thicknesses, no scenario is able to be located to satisfy the requirement, a structural engineer will have to be contracted to complete the design to suit the condition.

ABOVE GRADE WALL DESIGN = APPENDIX D

As in Below Grade Design, the designer again needs to know 5 pieces of data:

1. The desired core thickness that the client wishes to be used in the design (Unless there are tight spatial considerations, always start with 6" (152 mm)).
2. Whether the wall being considered is one of 3 scenarios
 - (a) The TOP floor of a one or two storey Nudura building
 - (b) The BOTTOM storey of a Nudura Building with light framed 2nd storey and roof
 - (c) The BOTTOM storey of a FULL two storey Nudura Building
 The 3rd scenario will usually require denser, or more, reinforcement than the first 2 scenarios.

3. The maximum height of the wall from the top surface of the ground floor to the underside of either the ceiling joists or roof trusses of either the 1st or 2nd floor.

4. The seismic condition anticipated for the site. (The higher the classification, the more steel will be required in the design.) This data can be gleaned from the applicable Building Code or identified by the local Building Official for your region.

5. The wind speed (or design wind pressure) for the site. Again, the higher the wind pressure, the more severe the steel placement or increased the bar diameter will be. Like the seismic data, you can obtain this pressure from the Building Code or your local Building Official.

TACOMA ENGINEERS **Nudura**

Above-Grade Walls: Vertical and Horizontal Steel Reinforcement for Walls Built with NUDURA Insulated Concrete Forms

Wall Height	Vertical Steel								Horizontal Steel All Scenarios
	Hourly Wind Pressure, $q/150 \leq 0.75 \text{ kPa (15.7 psf)}$								
	Seismic Zone Classification								
	$S_s(0.2) \leq 0.32$				$S_s(0.2) > 0.32 \text{ \& } \leq 0.67$				
	One Storey Concrete Structure or Top Floor of 2 Storey Concrete Structure Supporting Wood Frame Roof								
m (ft)	100 mm (4") Wall	150 mm (6") Wall	200 mm (8") Wall	250 mm (10") Wall	100 mm (4") Wall	150 mm (6") Wall	200 mm (8") Wall	250 mm (10") Wall	
2.44 (8)	10M @ 600 (24)	10M @ 800 (32)	10M @ 800 (32)	10M @ 800 (32)	10M @ 600 (24)	10M @ 800 (32)	10M @ 800 (32)	10M @ 800 (32)	10M @ 914 (36")
2.75 (9)	10M @ 400 (16)	10M @ 800 (32)	10M @ 800 (32)	10M @ 800 (32)	10M @ 400 (16)	10M @ 800 (32)	10M @ 800 (32)	10M @ 800 (32)	10M @ 914 (36")
3.05 (10)	10M @ 400 (16)	10M @ 600 (24)	10M @ 600 (24)	10M @ 600 (24)	10M @ 400 (16)	10M @ 600 (24)	10M @ 800 (32)	10M @ 800 (32)	10M @ 914 (36")
3.66 (12)	-	10M @ 400 (16)	10M @ 400 (16)	10M @ 600 (24)	-	10M @ 400 (16)	10M @ 400 (16)	10M @ 600 (24)	10M @ 914 (36")
4.27 (14)	-	15M @ 400 (16)	15M @ 600 (24)	15M @ 600 (24)	-	10M @ 400 (16)	15M @ 600 (24)	15M @ 600 (24)	10M @ 914 (36")
4.88 (16)	-	15M @ 400 (16)	15M @ 400 (16)	15M @ 400 (16)	-	15M @ 400 (16)	15M @ 400 (16)	15M @ 400 (16)	10M @ 914 (36")
	Lower Floor of 2 Storey Structure Supporting 2 nd Storey Wood Frame Walls, Floor and Roof								
2.44 (8)	10M @ 600 (24)	10M @ 800 (32)	10M @ 800 (32)	10M @ 800 (32)	10M @ 600 (24)	10M @ 800 (32)	10M @ 800 (32)	10M @ 800 (32)	10M @ 914 (36")
2.75 (9)	10M @ 400 (16)	10M @ 800 (32)	10M @ 800 (32)	10M @ 800 (32)	10M @ 400 (16)	10M @ 800 (32)	10M @ 800 (32)	10M @ 800 (32)	10M @ 914 (36")
3.05 (10)	-	10M @ 600 (24)	10M @ 600 (24)	10M @ 600 (24)	-	10M @ 600 (24)	10M @ 800 (32)	10M @ 800 (32)	10M @ 914 (36")
3.66 (12)	-	10M @ 400 (16)	10M @ 600 (24)	10M @ 600 (24)	-	10M @ 400 (16)	10M @ 400 (16)	10M @ 600 (24)	10M @ 914 (36")
4.27 (14)	-	-	15M @ 600 (24)	15M @ 600 (24)	-	-	15M @ 600 (24)	15M @ 600 (24)	10M @ 914 (36")
4.88 (16)	-	-	15M @ 400 (16)	15M @ 400 (16)	-	-	15M @ 400 (16)	15M @ 400 (16)	10M @ 914 (36")
	Lower Floor of 2 Storey Concrete Structure Supporting 2 nd Storey Concrete Walls and Wood Frame Floor & Roof								
2.44 (8)	10M @ 400 (16)	10M @ 800 (32)	10M @ 800 (32)	10M @ 800 (32)	10M @ 400 (16)	10M @ 800 (32)	10M @ 800 (32)	10M @ 800 (32)	10M @ 914 (36")
2.75 (9)	-	10M @ 600 (24)	10M @ 800 (32)	10M @ 800 (32)	-	10M @ 600 (24)	10M @ 600 (24)	10M @ 800 (32)	10M @ 914 (36")
3.05 (10)	-	10M @ 400 (16)	10M @ 600 (24)	10M @ 600 (24)	-	10M @ 400 (16)	10M @ 600 (24)	10M @ 600 (24)	10M @ 914 (36")
3.66 (12)	-	15M @ 600 (24)	15M @ 600 (24)	15M @ 600 (24)	-	10M @ 200 (8)	15M @ 400 (16)	15M @ 400 (16)	10M @ 914 (36")
4.27 (14)	-	-	15M @ 400 (16)	15M @ 400 (16)	-	-	15M @ 400 (16)	15M @ 400 (16)	10M @ 914 (36")
4.88 (16)	-	-	15M @ 200 (8)	15M @ 200 (8)	-	-	15M @ 200 (8)	15M @ 200 (8)	10M @ 914 (36")

Note:

1. Bolded data indicates reinforcing for ground floor concrete walls only. Second floor concrete walls to be limited to height of 3.05m (10'-0").
2. This table is to be used in conjunction with the "Design Limitations" prepared by Tacoma Engineers Inc.
3. Vertical wall steel spacing indicated in mm (in).
4. Refer to Design Limitations for information on construction methods, material specifications, design loads, additional wall reinforcing requirements and top openings in minimum wall length, etc.
5. 2-10M bars are permitted to replace each 15M bar at the specified spacing indicated above.

FIGURE 2.07

TABLE D-5 REINFORCEMENT FOR ABOVE GRADE WALLS
Wind Pressure $q/150 \leq 0.75 \text{ kPa (15.7 psf)}$
Low and Medium Risk Seismic Class

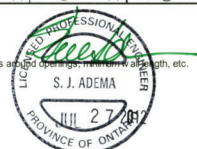

PROCEDURE

1. Knowing above information, from the Above Grade Design Tables select the correct design table from the options available, (based on wind pressure and seismic zone thickness (Low, Medium or High to the maximum condition noted). If your scenario is not listed, a professional engineer **MUST** be contracted to complete the design.
2. Once the table has been selected, from the left side of the table, identify the required wall height for your design from the very left hand column of the table.
3. Next, select the appropriate set of columns corresponding to the prevailing seismic zone of your site.
4. Finally, select your desired wall core thickness.
5. Note the required reinforcement for the condition at the corresponding cell to your required wall height and desired core thickness of concrete. If there is NO notation, it means that you must select a higher core thickness of concrete.
6. If no scenario can be located to satisfy the requirement after testing all subsequent core thicknesses, as in the Below Grade Tables, a structural engineer will have to be contracted to complete the design to suit the site condition.

LINTEL REINFORCEMENT DESIGN

Similar to the Wall Design Tables found in Appendix D, the Lintel Reinforcing Steel Design Tables in Appendix E apply to residential buildings **ONLY** that conform to the statement of limitations applied to the Prescriptive Design Requirements for Flat Wall Insulating Concrete Forms as noted in the IRC (USA) and under Part 9 of the NBC (CAN) (i.e. light frame roofs and light framed floor systems).

IMPORTANT NOTES REGARDING LINTEL DESIGN

Again, the Designer is cautioned to carefully review the design limits and notes that precede the Lintel Design Tables to assure that they fully understand what the limitations for application are. Of special importance within these notes is the fact that the tables are designed to resist **UNIFORMLY DISTRIBUTED LOADS ONLY**. Point loads as may be applied by girder trusses or beams have not been taken into consideration in the designs. In cases such as these, consideration should be made in your design to either:

- (a) Relocate the point load, if possible.
- (b) Relocate the opening.
- (c) If neither is possible, an engineer should be contracted to produce a stamped lintel design specific to the condition to carry the point load.

DETERMINING UNIFORMLY DISTRIBUTED LOADS

Nudura's lintel tables differ somewhat from design data that may be contained in some Code Prescriptive Material in that the user must calculate the anticipated Uniformly Distributed Load (or UDL) condition for your lintel design. The following procedure outlines how this is accomplished.

1. First, if you are a design builder and you have already ordered or commissioned truss drawings or floor trusses for the project, the accompanying paperwork from the truss company or joist manufacturer can be used to automatically give you the required uniformly distributed loads at the reaction or bearing points of the truss or floor joist/truss without having to calculate yourself. If you don't have truss drawings or pre-engineered floor system drawings, you will have to calculate these loads yourself as outlined below.

2. First you need to determine the anticipated Live and Dead Loads for the building.

Dead Loads (or DL) are defined as any load that forms a permanent part of the building structure, such as joists, trusses, sheathing, shingles, tiles, etc. (these will typically fall anywhere between 5 to 15 lbs/ft² (24.41 kg/m² or 0.239 kPa). If floor or roof finishes demand heavier materials (such as tiles or slate) find out their densities/area of coverage and be sure to add these to your loads.

Live Loads (or LL) are defined as any load that will act on the structure temporarily. These include occupants and furniture for floors, wind and, most importantly, snow loads for roofs. This data is already set by your local Building Code. Just as you did for the seismic and wind data for your wall design, consult either the code or your local building official for the assigned climatic and live load data for your area.

Occupant live loads will vary with occupancy type. See the list below for some examples of how these loads can change. The chances are, if you are using Nudura's tables for prescriptive design, you will only need to worry about residential live loads. However, if you are using the tables as a guide for quoting other work (that will involve engineer design at a later date) remember that lintel design for things such as offices, churches or theater type complexes will demand significantly more live load to be designed for, hence much more steel required for the lintels.

Residences: 40 lbs/ft² (195.30 kg/m² or 1.92 kPa)

Commercial: 50 lbs/ft² (244.12 kg/m² or 2.39 kPa)

Assembly: 100 lbs/ft² (488.24 kg/m² or 4.79 kPa)

3. Next, for each lintel condition, examine the opening condition in context to where it occurs in the building plan. (i.e. under a roof bearing or under a floor bearing condition). If the lintel condition is occurring in the bottom storey of a two storey building, although the roof condition in the storey above will exert some load, the majority of this load will be spread through the wall reinforcement occurring far above the lintel that's carrying the floor; the prominent load to be considered will be the condition immediately above the lintel (the floor load).
4. Note on the plan where the roof or floor trusses bearing onto the lintel span to the rest of the building. If it is a roof condition, chances are the roof truss may be spanning the full width of the plan. These are usually the most severe conditions of reinforcement. If the lintel will be carrying roof trusses, check whether or not there is a bearing wall in the middle of the floor plan carrying part of the roof truss. Note the dimensions of the span from the exterior bearing wall containing the opening, and the bearing condition on the opposite end of the truss or floor framing member.
5. If the opening is under a floor, the bearing point of the floor span will often be located in the middle of the building depth, particularly if standard floor joists are being used. In the case of engineered wood or framed floor systems (floor trusses), the spans will typically be longer, and perhaps will extend full depth/width of a floor plan to an exterior wall. Again, note the total span length of the structural member.
6. Now that you have the load data, calculating the uniformly distributed load (UDL) for your lintel conditions will be fairly easy. Nudura's lintel tables have been designed to assign the safety factors FOR you. As a designer, you need not apply any additional safety factors for live or dead loads as these have been computed INTO the results on the tables. To calculate UDL use this simple formula:

$$\text{UDL} = (\text{Total DL} + \text{Total LL}) \times \frac{1}{2} \text{ the span member length}$$

The result will give you a load expressed in lbs per linear foot (or kg per linear meter) ready for use in the next section.

INSTALLATION MANUAL

THE LINTEL DESIGN PROCESS

To use the Lintel Design Tables, you will need to know 4 pieces of data. These include:

1. The lintel's concrete core thickness
2. The available height in the wall above the lintel
3. The width of the opening required to be spanned
4. The total UDL calculated from above

1. Select the appropriate Lintel based on the easy number system listed in the lower right corner of each Table. The first digit stands for the lintel core thickness- the second 2 digits after the dash indicate the height or depth of the lintel in "inches". For example, as noted in Figure 2.08, Lintel No. L6-15 means that it will be a lintel for a 6" (152 mm) thick wall that will be 15" (381 mm) deep when completed. A common strategy established by many designers or builders is to try and stick with a common lintel height that can be repeated around the building with a common stirrup height for a broad range of openings. This way, if stirrups are ordered pre-bent from a metal fabricator, all stirrups can be ordered the same height for the entire job without worry of which lintel they will be assembled into. For this reason, where possible, select the lintel height that will enable this to happen easily without compromising on strength requirement. Garage door and wide window openings may be the exception that requires a differing height of lintel.

2. On the left side of the Table, select the opening width required to be spanned. The Tables cover an opening range from 3'-0" (900 mm) up to as much as 20'-0" (6.0 m) where lintel depths permit.
3. On the right side of the table, select the column that corresponds to or EXCEEDS your required UDL load that you calculated in the previous section. Here the load options range from a low of 480 lbs/ft (7.0 KN/m) to a maximum of 2,395 lb/ft (35.0 KN/m).
4. At the cell corresponding to both opening width and load record the information indicated. This will give 2 pieces of data:
 - (a) The number and diameter of steel bars required for forming the bottom bar portion of the lintel
 - (b) The stirrup end distance required (measured from the opening jamb condition back towards the middle of the opening) at which to begin placement of the stirrups if they are required for the lintel

If the stirrup end distance is noted as 0-inches, this means that NO shear stirrups will be required to construct the lintel.

Notice that each Table features a thick diagonal line that runs upward generally from the lower left to the upper right of each table, subdividing the cell data of the table into 2 separate sections. Any scenario appearing above or left of this line will NOT require shear stirrups. Anything below and right of this line WILL REQUIRE shear stirrups.

5. The final element is stirrup spacing. This can always be found in the NOTES section appearing at the bottom of the applicable table you are working with, specific for any condition noted on that particular table.
6. Do not forget as well, that the notes also detail options for substitution of bars, should the contractor or builder NOT have a larger desired bar on site for construction of the lintels.
7. The final step is to record the above sets of data into a lintel schedule for presentation with the drawings.

375mm (15") Lintel Depth
Uniformly Distributed Load

Opening Width	7.0 KN/m (158 lb/ft)		10.4 KN/m (235 lb/ft)		14.2 KN/m (315 lb/ft)		17.5 KN/m (388 lb/ft)		21.0 KN/m (455 lb/ft)		24.5 KN/m (538 lb/ft)		28.0 KN/m (615 lb/ft)		31.5 KN/m (698 lb/ft)		35.0 KN/m (775 lb/ft)			
	Reinf. Steel	Stirrup End Dist.	Reinf. Steel	Stirrup End Dist.	Reinf. Steel	Stirrup End Dist.	Reinf. Steel	Stirrup End Dist.	Reinf. Steel	Stirrup End Dist.	Reinf. Steel	Stirrup End Dist.	Reinf. Steel	Stirrup End Dist.	Reinf. Steel	Stirrup End Dist.	Reinf. Steel	Stirrup End Dist.		
900mm (3'-0")	1-10M	0	1-10M	0	1-10M	0	1-10M	0	1-10M	0	1-10M	0	1-10M	0	1-10M	0	1-10M	0	1-10M	0
1200mm (4'-0")	1-10M	0	1-10M	0	1-10M	0	1-10M	0	1-10M	0	1-10M	0	1-15M	406 (16")	1-15M	406 (16")	1-15M	406 (16")	1-15M	406 (16")
1500mm (5'-0")	1-10M	0	1-10M	0	1-10M	406 (16")	1-15M	406 (16")	1-15M	406 (16")	1-15M	609 (24")	1-15M	609 (24")	1-15M	609 (24")	1-15M	609 (24")	1-15M	609 (24")
1800mm (6'-0")	1-10M	0	1-15M	406 (16")	1-15M	406 (16")	1-15M	609 (24")	1-15M	609 (24")	1-15M	609 (24")	1-15M	812 (32")	1-15M	812 (32")	1-15M	812 (32")	1-20M	812 (32")
2400mm (8'-0")	1-15M	406 (16")	1-15M	609 (24")	1-15M	609 (24")	1-20M	812 (32")	1-20M	812 (32")	1-20M	1015 (40")	1-20M	1015 (40")	2-15M	1015 (40")	2-15M	1015 (40")	1-15M	1015 (40")
3000mm (10'-0")	1-15M	609 (24")	1-20M	406 (16")	1-20M	406 (16")	2-15M	1015 (40")	2-15M	1015 (40")	2-15M	1218 (48")	2-20M	1218 (48")	2-20M	1421 (56")	2-20M	1421 (56")	1-15M	1421 (56")
3600mm (12'-0")	1-20M	1015 (40")	2-15M	1218 (48")	1-15M	1218 (48")	2-20M	1421 (56")	2-20M	1421 (56")	2-20M	1624 (64")	2-20M	1624 (64")	2-20M	1827 (72")	2-20M	1827 (72")	1-15M	1827 (72")
4200mm (14'-0")	2-15M	1218 (48")	1-15M	1624 (64")	1-10M	1624 (64")	2-20M	1827 (72")	2-20M	1827 (72")	2-20M	2027 (80")	2-20M	2027 (80")	2-20M	2230 (88")	2-20M	2230 (88")	1-15M	2230 (88")
4800mm (16'-0")	1-15M	1624 (64")	1-10M	1827 (72")	1-10M	1827 (72")	2-20M	2027 (80")	2-20M	2027 (80")	2-20M	2230 (88")	2-20M	2433 (96")	2-20M	2433 (96")	2-20M	2433 (96")	1-15M	2433 (96")
5400mm (18'-0")	1-10M	1827 (72")	1-10M	2027 (80")	1-10M	2027 (80")	2-20M	2230 (88")	2-20M	2230 (88")	2-20M	2433 (96")	2-20M	2636 (104")	2-20M	2636 (104")	2-20M	2636 (104")	1-15M	2636 (104")
6000mm (20'-0")	1-10M	2027 (80")	1-10M	2230 (88")	1-10M	2230 (88")	2-20M	2433 (96")	2-20M	2433 (96")	2-20M	2636 (104")	2-20M	2839 (112")	2-20M	2839 (112")	2-20M	2839 (112")	1-15M	2839 (112")

NOTES
This table to be used in conjunction with the general notes and details located at the beginning of this section.
2. Stirrup Spacing = 203mm (8")

All Stirrup End Distance measurements above are listed in mm (in)

The following substitutions are permitted:
1-10M * 1-15M may be substituted for 1-20M
2-10M may be substituted for 1-15M

Table Prepared by: **TACOMA ENGINEERS**

Table No. **L 6-15M**

FIGURE 2.08

2.1.3 REQUIRED WALL THICKNESS

Although the following information may not directly pertain to prescriptive design, this simple reference matrix is produced below (Figure 2.09) to assist engineers, designers and contractors alike in selecting an appropriate core thickness of Nudura forms for optimum wall performance (i.e. to yield the most efficient combination of concrete and steel for required condition).

IMPORTANT NOTE: The recommendations contained in this document are intended as a general guideline only and should not be construed as a substitute for proper engineered design to ACI 318 (USA) or CAN/CSA A23.3 (CAN) Standards. Rather, this document is intended as a guideline to aid in selection of an appropriate form thickness for a suggested wall height or building type for budget, quotation or preliminary design consideration purposes ONLY.

In addition, also bear in mind that changes in the Canadian Concrete Design Standard in 2004 (CSA A23.3-04), may dictate larger core thicknesses than are projected by this table. For example, single warehouse or gymnasium heights of 22' to 25' (6.7 m to 7.6 m) previously found to be in conformance with slenderness ratios of the 1994 Code when constructed with 8 inch (203 mm) core walls MAY be required by your engineer to be larger than shown here if the design condition is close to the maximum heights shown in this table.

In addition, it is important to note that special local contributing factors such as high clay content in soils, high seismic velocities, or wind pressures in excess of 21 psf (20 mph to 40 mph) or 1.0 KPa (32 km/h to 64km/h) may dictate selection of a thicker core form if the design condition is close to the maximum heights suggested in this table. In most cases, the suggested recommendations herein will result in optimum reinforcing patterns capable of resisting the required loadings for each scenario. Wherever the term "Consult Engineering" is used, this suggests that one should consult professional design advice regarding the core thickness being considered for the height noted before making a decision to use the core thickness noted in the quotation or estimation.

FORM THICKNESS	BASEMENT/FOUNDATION LIMITS	SINGLE STOREY LIMITATION	MULTI STOREY LIMITATION	COMMON BUILDING TYPES
4" 102 mm	Basement not permitted Frost/Stem wall only. subject to engineering consultation	Safe to 10' > 10' Consult Engineering	2 stories 10' floor + gable end 12/12 pitch	Exterior walls of: houses – single, semi & townhouse, small offices single or 2 storey
6" 152 mm	8' – clay 9' – gravel 10' – Consult Engineering	Safe to 14' – 16' >16' – Consult Engineering	3 stories 4 with Eng. Design 10'-14' ht/floor	Almost any building type – maximum 16' single storey height without pilasters
8" 203 mm	9' – clay 10' – gravel 11' – Consult Engineering	Safe to 16' – 25' >25' – Consult Engineering	Lower 2-4 floors of 5-8 stories (use 6" on upper 2-3 stories)	Warehouses, theatres, church tall walls lower floors of hotels, condos, apartments
10" 254 mm	10' – clay 11' – gravel 12' – Consult Engineering	Safe to 25' – 35' >35' – Consult Engineering	Lower 2-4 floors of 9-12 stories	Under ground garages, theatre walls, fly lofts lower floors of hotels, condos, apartments
12" 305 mm	11' – clay 12' – gravel ≥13 Consult Engineering	Safe to 35' – 40' >40' – Consult Engineering	Consult Engineering	Heavy tall industrial applications deep foundation walls

FIGURE 2.09

2.1.4 LAYOUT PLANNING USING NUDURA FORMS

In the move from traditional wall systems to the use of Nudura Integrated Building Technology in the construction industry, there are important elements for the contractor/installer to consider especially with respect to plan layouts.

First and foremost is the overall wall thickness. Unlike many other traditional walls, the exterior face of a Nudura wall is located a full 2 5/8" (67 mm) distance from the concrete core it contains. Therefore, if an engineer specifies the exterior limit of his structure relative to a grid line, ensure that the architectural detail and plan always reflects that the exterior of the building is located such that the exterior insulation will lie outboard of the grid line, clear of this element.

The concrete core also has insulation on the interior face of the wall, which is located 2 5/8" (67 mm) from the inside face of the concrete core. This means that no matter what the structural drawings for the building show, the architectural plan will reflect a wall thickness that is 5 1/4" (133 mm) thicker than the actual concrete core.

Appendix A of this manual contains the form unit profiles for each unit available in the Nudura lineup. Although each form in Appendix A is shown with a 6" (152 mm) concrete core, alternative core thicknesses are available and details for each of these can be obtained from Nudura through your local distributor. The geometry of the 90° and 45° profiles strongly dictate the dimensions that will follow for "Nudura Friendly" layout dimensions. These dimensions are based on 3 very important rules of on-site installation which are as follows:

1. Both corner units (45° and 90°) are formed so that they can be bond stacked, course on course, with each other to create an ideal 16" (406 mm) overlap with the interfacing standards. This practice encourages consistency from course to course and maintains maximum strength in the construction of the wall for handling concrete pressures.
2. To maintain the geometry in Point 1 above, this manual teaches installer/contractors to avoid cutting corners, hence the layout tables reflect this philosophy. Only when designers require tight corner changes will the contractor/installer entertain cutting a corner form unit to achieve an in-field build. The reason Nudura tries not to cut the corner forms is that under concrete pressure is increased pressure in these areas. This practice also better maintains an ideal offset of 16" (406 mm) when the corner forms are reversed on successive course placement, as shown in Figure 2.11.
3. The standard forms that are assembled within each course between the corners and T form units work best if the cut length of form occurs in multiples of 8" (203 mm). This assures that the vertical interlock of the webs will be maintained everywhere throughout the wall height. This is ideal for both the contractor/installer and the end user in that, at every location, the webs are assured to be in-line for drywall and other finish attachments both interior and exterior. This also allows the building owner or occupant to know where fastening is possible for the anchorage of decorative and storage elements. It should be noted that the wall can, if necessary, be constructed to ANY dimension required by the designer. However, optimum layouts will result best if the 8" (203 mm) increment recommendation is followed.

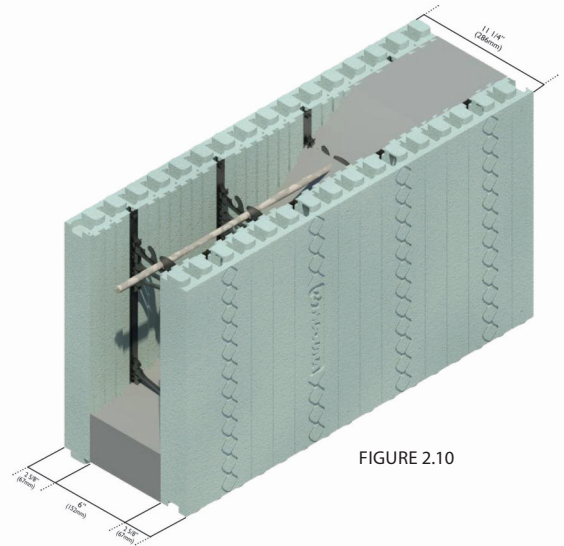

FIGURE 2.10

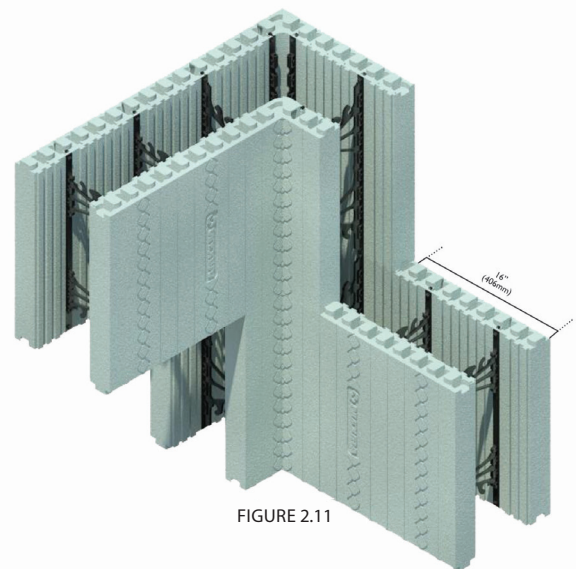

FIGURE 2.11

IMPORTANT NOTES REGARDING APPLICATION OF “NUDURA FRIENDLY” DIMENSIONS

Though a designer may use this information to ensure the most optimal design for Nudura form units possible, there are factors to be considered in the planning and final installation of the product in-field:

Not every designated wall of a Nudura plan layout can be designed to be optimally laid out to “Nudura Friendly” dimensions. This is definitely true for building layouts where there are odd numbers of outside or inside corners. In such cases, ONE of the intersecting dimensions to the odd corner MUST be sacrificed to meet the optimal layout condition. The non-conforming plan dimension can simply be indicated on the plan to alert the in-field contractor that one of the walls intersecting this corner will have to be custom built with a smaller than 8”(203 mm) increment.

In the perfect world of computer aided design, dimensional layouts are always exact. Despite the intent of achieving perfect Nudura dimensioning, the designer and contractor should bear in mind that ICF products being formed with EPS foam are subject to minor product dimensional tolerances that must be taken care of in the final in-field build. While Nudura quality control processes strive to achieve tolerances within $\pm \frac{1}{8}$ ” (3.2 mm), form unit length tolerances can vary by as much as $\frac{1}{8}$ ” (3.2 mm) shorter or up to $\frac{3}{8}$ ” (9.5 mm) longer on an 8’ (2.44 m) standard form as a result of variances in, EPS bead type, EPS pre-expansion levels, bead aging time, manufacturing plant humidity and temperature at time of molding, and rate of post-mould shrinkage. Generally the product is rarely on the high or low end of these tolerances. Nudura’s manufacturing facilities take great pride in ensuring that all products produced maintain a constant dimension. However, both designer and contractor/installer must be ever mindful that accommodation of this factor may, at some point in time, have to be made in the final installation.

CORNER TO CORNER FORM LAYOUT SCENARIOS

On the basis of the key assumptions noted above, Nudura has created layout tables for every core thickness of form offered, for planning scenarios, involving each of the wall profile intersections noted below. The number of tables necessary to cover scenarios by reference table for wall lengths up to 50’ (15.24 m) is too numerous to publish in hard copy here. However, should the contractor/installer need a copy of these tables, please contact the local distributor.

Figure 2.12 is a typical example of how to use these tables to quickly identify the closest “Nudura Friendly” dimension for the condition required for each wall segment of the proposed plan layout. In the instructions in each case remember that the scenarios given at the start of the tables indicate dimensions achievable if, and when, field condition demands that the corner form be cut.

Example FORM UNIT LAYOUT CHARTS

Corner to Corner Layout Charts	
Step 1: Locate Chart that coincides with your core thickness and corner condition.	
Step 2: Find dimension closest to that which you desire for the corner condition.	
Step 3: Closest dimensions to 20' (6100 mm) are 19' 10 5/8" (6057 mm) or 20' 6 5/8" (6260 mm), so for example take 19' 10 5/8" as the overall wall length.	
Step 4: Subtract initial length of two corner forms (first unshaded cell) from Dimension A. Eg 19' 10 5/8" - 3' 2 5/8" = 16' 8"	
Step 5: Calculate number of standards between. Balance is 16' 8" or (5080 mm), so divided by 8' (2438 mm) to give, 2 standard blocks and one 8" (200 mm) piece of standard block.	

8" (200 mm) 90° to 45° Corner Form Units			
Dim. A (Imp)	Dim. A (Met. mm)	Dim. A (Imp)	Dim. A (Met. mm)
1' 10 5/8"	576		
2' 6 5/8"	779		
3' 2 5/8"	982	27' 2 5/8"	8290
3' 10 5/8"	1185	27' 10 5/8"	10293
4' 6 5/8"	1388	28' 6 5/8"	12296
5' 2 5/8"	1591	29' 2 5/8"	14299
5' 10 5/8"	1794	29' 10 5/8"	16302
6' 6 5/8"	1997	30' 6 5/8"	18305
7' 2 5/8"	2200	31' 2 5/8"	20308
7' 10 5/8"	2403	31' 10 5/8"	22311
8' 6 5/8"	2606	32' 6 5/8"	24314
9' 2 5/8"	2809	33' 2 5/8"	26317
9' 10 5/8"	3012	33' 10 5/8"	28320
10' 6 5/8"	3215	34' 6 5/8"	30323
11' 2 5/8"	3418	35' 2 5/8"	32326
11' 10 5/8"	3621	35' 10 5/8"	34329
12' 6 5/8"	3824	36' 6 5/8"	36332
13' 2 5/8"	4027	37' 2 5/8"	38335
13' 10 5/8"	4230	37' 10 5/8"	40338
14' 6 5/8"	4433	38' 6 5/8"	42341
15' 2 5/8"	4636	39' 2 5/8"	44344
15' 10 5/8"	4839	39' 10 5/8"	46347
16' 6 5/8"	5042	40' 6 5/8"	48350
17' 2 5/8"	5245	41' 2 5/8"	50353
17' 10 5/8"	5448	41' 10 5/8"	52356
18' 6 5/8"	5651	42' 6 5/8"	54359
19' 2 5/8"	5854	43' 2 5/8"	56362
19' 10 5/8"	6057	43' 10 5/8"	58365
20' 6 5/8"	6260	44' 6 5/8"	60368
21' 2 5/8"	6463	45' 2 5/8"	62371
21' 10 5/8"	6666	45' 10 5/8"	64374
22' 6 5/8"	6869	46' 6 5/8"	66377
23' 2 5/8"	7072	47' 2 5/8"	68380
23' 10 5/8"	7275	47' 10 5/8"	70383
24' 6 5/8"	7478	48' 6 5/8"	72386
25' 2 5/8"	7681	49' 2 5/8"	74389
25' 10 5/8"	7884	49' 10 5/8"	76392
26' 6 5/8"	8087	50' 6 5/8"	78395

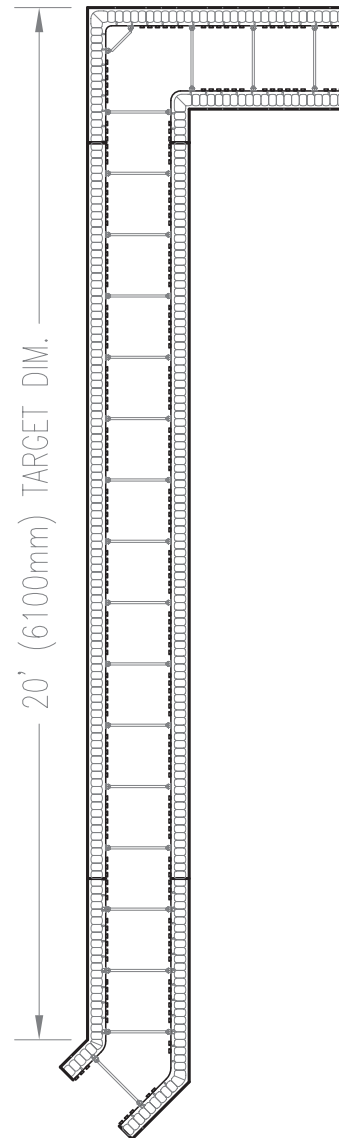

FIGURE 2.12

RADIUS WALL SCENARIOS

Radius walls are formed simply through the use of Nudura's straight 8' (2.44 m) standard form unit panel system coupled with Nudura's cross linked insert webs. The contractor/installer does not need to worry about perfect configuration of "Nudura Friendly" dimensions for radius wall designs since coordination of in-field construction is largely handled through the custom radius cuts that are made at the factory. Tremco CPG Inc. has developed a simple Radius Wall Calculation Spread Sheet which assists the contractor/installer and designer in knowing what lengths of form cuts will be made by the computer program at our plant to facilitate the cutting of the segments to construct a radius wall. Should the contractor/installer require a copy of the electronic version for in-field cutting of a radius wall, please contact the local distributor. For more information on radius walls, refer to the Technical Bulletin on this subject, included in Appendix F.

2.1.5 WALL HEIGHT CHARTS

Stack heights for ensuring wall heights are achieved with Nudura construction can be particularly important especially when considering such things as:

- Footing elevations relative to grade
- Brick finishes relative to grade levels
- Floor bearing heights relative to finished grade
- Floor bearing height relative to each other

Nudura's form heights do not always need to be considered for elevation design layout. Contractor/installers working regularly with the Nudura Wall System will plan stack heights to suit the elevation layout requirements of the building as assigned by the architect or designer, no matter what this may be. However, if the designer requires optimum conditions for ease of construction of Nudura on site, here is a list of tips to remember for achieving optimum design for installation of Nudura forms:

- Avoid using height adjusters or use them sparingly. Using height adjusters will add to the labor cost due to the fact that they are 32" (813 mm) in length by 3" (76 mm) high. The man-hours/ft² (man-hours/m²) will increase significantly for this area of the wall. Therefore, if floor heights can be coordinated with the design to avoid use of height adjusters, this will serve to make the project more cost efficient.
- If a half form will achieve optimum stack height within the projected wall assembly from top of footing to parapet or roof line, plan to use the half height form at either the footing or the top of the wall or roof line. Do NOT specify half height forms at any portion of a continuous stack height as this will cause additional form support to have to be added by the installer prior to concrete placement.
- When installing brick ledges, it is recommended to adjust the height of the first course in order to ensure that the brick line starts at a full course. If this is not possible then the brick elevation can be achieved by using the Nudura Brick Ledge Extension Form.
- When planning complex details, always remember that if full height hinge pin web forms are being used, the crucial structural hinge pin ties that connect the panels together start at 2" (50 mm) from the top and bottom of the form and are each 3" (76 mm) in height. Avoid any detailing that will require the installer to cut the form in this region. If this is unavoidable, be sure to detail it as an insert web form and the installer will order and install accordingly, and will detail the web connections to handle the condition of bearing accordingly.
- Avoid using Brick Ledge Forms as floor supports for any application. Brick Ledge Forms have limited bearing capacities and therefore should not be relied on for carrying floor loads. Additional finishing requirements of the corbel could prove undesirable to the building owner.

INSTALLATION MANUAL

The following are optimal stack height charts for planning wall stack heights up to 36' 6" (11.125 m) in height. Obviously, higher wall heights are possible and employ the same basics of geometry as illustrated on the following pages.

IMPERIAL OR U.S. STANDARD DIMENSION WALL HEIGHT CHART

NO. OF COURSES	STANDARD FORM HEIGHT OF WALL (FT/IN)	PLUS ONE 3" HIGH HEIGHT ADJUSTER (FT/IN)	PLUS ONE 6" HIGH HALF OPTIMIZER (OR CUT STANDARD) (FT/IN)	PLUS ONE 9" HIGH HALF STANDARD (FT/IN)	PLUS ONE 12" HIGH OPTIMIZER FORM (FT/IN)	PLUS ONE 15" HIGH SEGMENT (FT/IN)
1	1' 6"	1' 9"	2'	2' 3"	2' 6"	2' 9"
2	3'	3' 3"	3' 6"	3' 9"	4'	4' 3"
3	4' 6"	4' 9"	5'	5' 3"	5' 6"	5' 9"
4	6'	6' 3"	6' 6"	6' 9"	7'	7' 3"
5	7' 6"	7' 9"	8'	8' 3"	8' 6"	8' 9"
6	9'	9' 3"	9' 6"	9' 9"	10'	10' 3"
7	10' 6"	10' 9"	11'	11' 3"	11' 6"	11' 9"
8	12'	12' 3"	12' 6"	12' 9"	13'	13' 3"
9	13' 6"	13' 9"	14'	14' 3"	14' 6"	14' 9"
10	15'	15' 3"	15' 6"	15' 9"	16'	16' 3"
11	16' 6"	16' 9"	17'	17' 3"	17' 6"	17' 9"
12	18'	18' 3"	18' 6"	18' 9"	19'	19' 3"
13	19' 6"	19' 9"	20'	20' 3"	20' 6"	20' 9"
14	21'	21' 3"	21' 6"	21' 9"	22'	22' 3"
15	22' 6"	22' 9"	23'	23' 3"	23' 6"	23' 9"
16	24'	24' 3"	24' 6"	24' 9"	25'	25' 3"
17	25' 6"	25' 9"	26'	26' 3"	26' 6"	26' 9"
18	27'	27' 3"	27' 6"	27' 9"	28'	28' 3"
19	28' 6"	28' 9"	29'	29' 3"	29' 6"	29' 9"
20	30'	30' 3"	30' 6"	30' 9"	31'	31' 3"
21	31' 6"	31' 9"	32'	32' 3"	32' 6"	32' 9"
22	33'	33' 3"	33' 6"	33' 9"	34'	34' 3"
23	34' 6"	34' 9"	35'	35' 3"	35' 6"	35' 9"
24	36'	36' 3"	36' 6"	36' 9"	37'	37' 3"

Note: The 15" segment can be achieved by cutting a Standard Form or using one Optimizer Form and one Height Adjuster

FIGURE 2.15

METRIC DIMENSION WALL HEIGHT CHART

NO. OF COURSES	STANDARD FORM HEIGHT OF WALL (METERS)	PLUS ONE 7.2 mm HIGH HEIGHT ADJUSTER (METERS)	PLUS ONE 152 mm HIGH HALF OPTIMIZER (OR OUT STANDARD) (METERS)	PLUS ONE 229 mm HIGH HALF STANDARD (METERS)	PLUS ONE 305 mm HIGH OPTIMIZER FORM (METERS)	PLUS ONE 381 mm HIGH SEGMENT (METERS)
1	0.457	0.533	0.610	0.686	0.762	0.838
2	0.914	0.991	1.067	1.143	1.219	1.295
3	1.372	1.448	1.524	1.600	1.676	1.753
4	1.829	1.905	1.981	2.057	2.133	2.210
5	2.286	2.363	2.438	2.514	2.590	2.668
6	2.743	2.820	2.895	2.971	3.047	3.125
7	3.201	3.277	3.352	3.428	3.504	3.582
8	3.658	3.734	3.809	3.885	3.961	4.040
9	4.116	4.192	4.266	4.342	4.418	4.497
10	4.573	4.649	4.723	4.799	4.875	4.955
11	5.030	5.106	5.180	5.256	5.332	5.412
12	5.488	5.564	5.637	5.713	5.789	5.869
13	5.945	6.021	6.094	6.170	6.246	6.327
14	6.403	6.478	6.551	6.627	6.703	6.784
15	6.861	6.936	7.008	7.084	7.160	7.242
16	7.317	7.393	7.465	7.541	7.617	7.699
17	7.775	7.850	7.922	7.998	8.074	8.156
18	8.232	8.307	8.379	8.455	8.531	8.614
19	8.690	8.765	8.836	8.912	8.988	9.071
20	9.147	9.222	9.293	9.369	9.445	9.529
21	9.604	9.679	9.750	9.826	9.902	9.986
22	10.062	10.137	10.207	10.283	10.359	10.443
23	10.519	10.594	10.664	10.740	10.816	10.901
24	10.977	11.051	11.121	11.197	11.273	11.358

Note: The 381mm segment can be achieved by cutting a Standard Form or using one Optimizer Form and one Height Adjuster

FIGURE 2.16

2.2 ESTIMATING

2.2.1 IMPERIAL (US STANDARD) FORMULAE

Nudura material requirements for any project can easily be determined manually through the simple calculations within this manual. In all cases the estimator must collect the following information from the plan in order to ensure the estimate is accurate.

Please refer to Section 2.2.2 for Metric Calculation Formulae.

Total linear footage of perimeter _____

Total # of 90° corners _____

Total # of 45° corners _____

Total linear footage of tapered top form _____

Total linear footage of brick ledge form _____

Total linear footage of brick ledge extension _____

Height of the wall _____

Total # of courses _____

Total linear footage of optimizer _____

Total linear footage of height adjusters _____

Total # of courses of height adjusters _____

Total linear footage to be waterproofed _____

Total height to be waterproofed _____

Total linear footage to be parged _____

Total height to be parged _____

Total ft² of openings (width x height) _____

Total linear footage of opening width _____

Total linear footage of opening height _____

Wall cavity thickness _____

The estimator will need to take the total lineal footage of the building and add 2 ft for each inside 90° corner and 1 ft for each inside 45° corner on the footprint.

This chart enables an estimator working in imperial or US Standard dimensions to easily summarize the necessary information regarding total opening width and height for estimating rough buck material along with the total ft² of openings there are in the building. These totals will be used in estimating formulas further on in this section.

IMPERIAL OR US STANDARD DIMENSION OPENINGS SUMMARY CHART				
OPENING #	QUANTITY	X WIDTH	X HEIGHT	= TOTAL FT ²
TOTALS				

TO CALCULATE THE STANDARD FORM UNITS:

- Gross Wall Area (ft²) = Total Linear footage of wall (ft) x Total Height (ft)
- Net Wall Area (ft²) = Gross Wall Area (ft²) – Total area of openings (ft²)
- Total Standards/course = (Total Linear footage of wall – (# 90° Corners x 4) – (# 45° Corners x 3)) ÷ 8
- Total Standards before deductions = Total Standards/course x # of courses

If brick ledge or taper top are needed for the building they need to be subtracted off the total standards calculated above.

- Standards (BL) = Lineal Footage of Brick Ledge ÷ 8
- Standards (TT) = Lineal Footage of Taper Top ÷ 8
- Standards (OP) = ((LFOP x # COP) ÷ 4) ÷ 3
- Total Standards = Total Standards before deductions - Standards (BL) - Standards (TT) - Standards (OP)

TO CALCULATE THE NUMBER OF 90° CORNER FORMS:

$$90^\circ \text{ form} = \#90 \times \#C$$

This formula multiplies the number of 90° turn by the number of courses.

TO CALCULATE THE NUMBER OF 45° CORNER FORMS:

$$45^\circ \text{ form} = \#45 \times \#C$$

This formula multiplies the number of 45° turn by the number of courses.

TO CALCULATE THE NUMBER OF BRICK LEDGE FORMS:

$$BLF4 = LFBLF \div 4 \text{ or } BLF8 = LFBLF \div 8$$

This formula divides the linear footage of brick ledge form units by 4 or 8. Brick Ledge forms are available in 2 lengths. 8' lengths are available from Nudura's Canadian plant and the 4' length is available from the US plant.

Note: Additional brick ledge form units may be required for corners.

TO CALCULATE THE NUMBER OF BRICK LEDGE EXTENSIONS:

$$\begin{aligned} BLE &= LFBLE \times .375 \\ \# \text{ of Screws} &= BLE \times 3 \\ \# \text{ of V Strips} &= BLE \div 3 \end{aligned}$$

This formula multiplies the linear footage of brick ledge extension by .375. The formulas also calculate the number of screws needed for attaching the BLE and also the V Strips needed also.

Note: Additional brick ledge extension may be required for corners.

TO CALCULATE THE NUMBER OF OPTIMIZER FORMS:

$$\begin{aligned} OP &= (LFOP \times \# \text{ COP}) \div 4 \\ OP \text{ Ties} &= OP \times 6 \end{aligned}$$

This formula corrects the linear footage of perimeter of Optimizer required, divides by 4, multiplies by 2 and multiplies by the number of courses required.

TO CALCULATE THE NUMBER OF HEIGHT ADJUSTERS:

$$\begin{aligned} HA &= (LFHA \times 2 \times \#CHA) \div 2.67 \\ HA \text{ Ties} &= (HA \div 2) \times 4 \end{aligned}$$

This formula corrects the linear footage of perimeter of Height Adjuster required, divides by 2.67', multiplies by 2 and multiplies by the number of courses required.

TO CALCULATE THE NUMBER OF ROLLS OF WATERPROOFING:

$$WP = LFWP \times HWP \div 210$$

A roll of waterproofing is 225 sq. ft. but the effective coverage is 210 sq. ft allowing for overlapping the edge of the membrane.

TO CALCULATE THE NUMBER OF BAGS OF PRECOAT PARGING MIX:

$$PC = LFPAR \times HPAR \div 75$$

The surface area to be parged is divided by 75 which is the average coverage obtained per bag for two coat application.

TO CALCULATE THE NUMBER FIBER MESH ROLLS:

$$FM = LFPAR \times HPAR \div 475$$

A roll of fiber mesh is 475 sq. ft. an allowance for overlap may be required depending on the application techniques.

TO CALCULATE THE QUANTITY OF WALL ALIGNMENT SYSTEM:

$$WAS = LFPER + 1 \text{ per corners or tees} \div 5.333$$

The formula allows for one unit every 5' 4" plus an additional unit for every corner and tee wall connection. Should a site have numerous openings with center of opening less than 5' 4" apart the quantity of WAS may need to be increased.

TO CALCULATE THE AMOUNT OF REBAR:

How to Determine the Required Reinforcing Steel to Wall Area "Ratio"

The ratios shown in Table 2.2.1.1 (below) have been calculated by totaling the bar length specified for each scenario then dividing this length by the total square footage of wall area that encompasses these bars. Using this method, a ratio can be specified for both vertical and horizontal mats of steel separately (if they are different diameters from each other) Or if both mats are the same diameter of steel, the ratio can be specified as a "Combined Steel Mat".

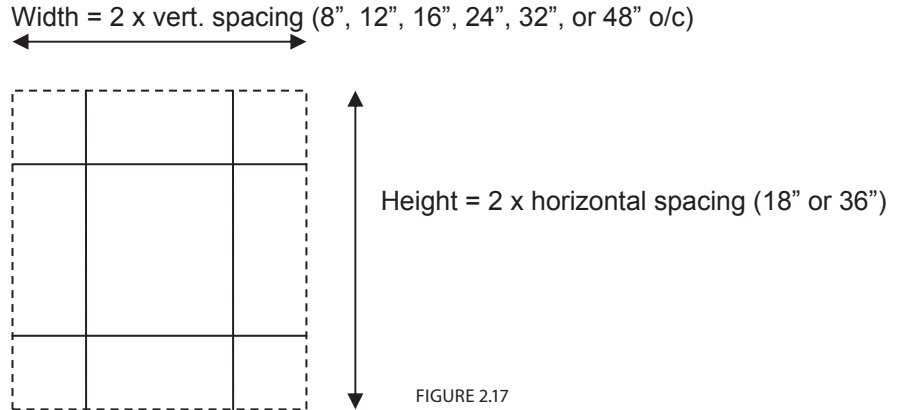

FIGURE 2.17

Table 2.2.1.1

	Vert. o/c Spacing (in.)	Horiz. o/c Spacing (in.)	Ratio LF/SF of Wall Single Mat	Ratio LF/SF of Wall Double Mat
Vertical Only Steel Mat	8"	-	1.500	3.000
	16"	-	0.750	1.500
	24"	-	0.500	1.000
	32"	-	0.375	0.750
	48"	-	0.250	0.500
Horizontal Only Steel Mat	-	18"	0.750	1.500
	-	36"	0.375	0.750
Combined Steel Mat	8"	18"	2.250	4.500
	8"	36"	1.875	3.750
	16"	18"	1.500	3.000
	16"	36"	1.125	2.250
	24"	18"	1.250	2.500
	24"	36"	0.875	1.750
	32"	18"	1.125	2.250
	32"	36"	0.750	1.500
	48"	18"	1.000	2.000
	48"	36"	0.625	1.250

REBAR = LPPER X HW X Multiplier (see Table 2.2.1.1)

The linear footage of the wall is multiplied by the height of the wall and multiplied by a value obtained in Table 1.0 which is a constant. The result is in feet. This constant is for a rebar grid in the wall 18" x 16" horizontally and vertically respectively with an allowance for horizontal splices.

TO CALCULATE THE VOLUME OF CONCRETE:

$$\text{Yds}^3 \text{ of concrete} = \text{LPPER} \times \text{HW} \times \text{MULTIPLIER (Table 2.2.1.1)}$$

The concrete multipliers shown in Table 2.2.1.2 (below) are constants, each of which represents the total volume of concrete (in cubic yards) that is necessary to cover 1 square foot of wall area for the specified core thickness of form. To calculate the amount of concrete required to fill the wall, simply multiply the total area of the wall (in square feet) by the multiplier shown for the selected core thickness of form. The volume of concrete ordered should be reduced in accordance with window and door openings. If using a concrete pump as a method of placement, an allowance must be included within the calculated volume of concrete to account for waste. Nudura recommends an additional concrete volume of 1 yd³ to 2 yd³ for the pump unit.

TABLE 2.2.1.2

Concrete Core Size	Concrete Multiplier
4.25"	0.013
6.25"	0.019
8.25"	0.026
10.25"	0.032
12.25"	0.038

TO CALCULATE THE NUMBER OF VERTICAL JOINT CLIPS:

$$\text{VJC} = (\text{LPPER} \div 8' \times 4 \text{ per standard} \times \# \text{ of courses}) + (\# \text{ of Corners} \times 4 \times \# \text{ of courses})$$

The VJC formula takes the lineal footage of the perimeter of the structure and divides by the length of a standard form. Then multiply this by 4 per standard form and then multiply again by the number of courses. The second part of this formula then takes the number of corners and multiplies by 4 clips per corner and then multiplies by the number of courses.

Note: Remember that what is in the brackets must be completed before adding them together for the total number of clips.

ESTIMATING FORMULAE SUMMARY – (IMPERIAL/ US STANDARD)**STANDARD FORM UNITS:**

Gross Wall Area (ft²) = Total Linear footage of wall (ft) x Total Height (ft)

Net Wall Area (ft²) = Gross Wall Area (ft²) – Total area of openings (ft²)

Total Standards/course = (Total Lineal footage of wall – (# 90° Corners x 4) – (# 45° Corners x 3)) ÷ 8

Total Standards before deductions = Total Standards/course x # of courses

Standards (BL) = Lineal Footage of Brick Ledge ÷ 8

Standards (TT) = Lineal Footage of Taper Top ÷ 8

Standards (OP) = ((LFOP x # COP) ÷ 4) ÷ 3

TOTAL STANDARDS = Total Stds before deductions - Stds (BL) – Stds (TT) - Stds (OP)

90° FORM UNIT: 90° FORM = #90 x #C

45° FORM UNIT: 45° FORM = #45 x #C

BRICK LEDGE FORM 4' UNIT: BLF4 = LFBLF ÷ 4

BRICK LEDGE FORM 8' UNIT: BLF8 = LFBLF ÷ 8

OPTIMIZER FORM UNIT: OP = (LFOP x # COP) ÷ 4

OP Ties = OP x 6

BRICK LEDGE EXTENSION: BLE = LFBLE x 0.375

of Screws = BLE x 6

HEIGHT ADJUSTER: HA = (LFHA x 2 x #CHA) ÷ 2.67

HA Ties = (HA ÷ 2) x 4

WATERPROOFING: WP = LFWP x HWP ÷ 210

PARGING COAT: PC = LFPAR x HPAR ÷ 75

FIBER MESH: FM = LFPAR x HPAR ÷ 475

WALL ALIGNMENT SYSTEMS: WAS = (LFPER + 1 per corner or tees) ÷ 5.33

REBAR: REBAR = LFPER x HW x 1.5

CONCRETE (IMPERIAL) Yds³ = LFPER x HW x Concrete Multiplier (Table 2.2.1.2)

VERTICAL JOINT CLIPS VJC = (LFPER ÷ 8' x 4 per standard x # of courses) + (# of Corners x 4 x # of courses)

ESTIMATING RADIUS WALLS (IMPERIAL OR US STANDARD)

For determining total number of radius forms required for on site construction of a Nudura radius wall or for preparing an order for factory cut Nudura radius forms, you can use the calculation formula below. This formula assumes that any radius constructed will be an “arc length segment” of a full circle with a known angle of rotation:

The following information is required to determine total number of radius forms for any given radius wall in a floor plan:

1. The Outside radius (measured in inches from the focus point to the outside face of the Nudura form)
2. The Inside Radius (equals the Outside Radius in inches less the total form thickness being used)
3. The Degrees of Turn of Radius (this is total number of degrees of rotation that the radius covers of a full circle)
4. The Total Wall Height (measured in inches).

TO CALCULATE THE TOTAL NUMBER OF RADIUS FORMS REQUIRED:

$$\begin{array}{rcc} & \text{No. of forms per course} & \text{No. of courses} \\ \text{No. of Forms} = & \text{Outside Radius (in inches)} \times 6.283 \times (\text{Degrees of Turn of Radius}/360) & \times \text{Wall Height (in inches)} \\ & \hline & 96 & \hline & & 18 \end{array}$$

NOTES:

1. To assure adequate product for accommodating custom fitting of the wall forms into the standard elements of the plan, the first part of the calculation (no. of forms per course) above should be **ROUNDED** up to a whole number or (full form length) before multiplying by the number of courses of forms required.
2. Do **NOT** deduct any allowance for openings particularly if placing orders at the factory for custom radius forms.

As an alternate, you can also obtain Nudura’s radius wall form unit spread sheet calculator through your distributor which enables the same calculation to be performed in Microsoft excel® along with giving the required cut segment lengths. (The distributor can also duplicate the quantity portion of this calculator by entering data into the Nudura radius wall digital order form).

Further guidance on estimating for Nudura radius walls is available through your Nudura distributor OR can be downloaded directly from the Construction Professional Section of Nudura’s Website under “Technical Bulletins and Guides”.

2.2.2 METRIC FORMULAE

Nudura material requirements for any project can easily be determined manually through the simple calculations within this manual. In all cases the estimator must collect the following information from the plan in order to ensure the estimate is accurate.

Please refer to section 2.2.1 for the imperial formulas.

Total linear meters of perimeter _____

Total # of 90° corners _____

Total # of 45° corners _____

Total linear meters of tapered top form _____

Total linear meters of brick ledge form _____

Total linear meters of brick ledge extension _____

Height of the wall _____

Total # of courses _____

Total linear meters of height adjusters _____

Total linear meters of optimizer _____

Total # of courses of height adjusters _____

Total linear meters to be waterproofed _____

Total height to be waterproofed _____

Total linear meters to be parged _____

Total height to be parged _____

Total m² of openings (width x height) _____

Total linear meters of opening width _____

Total linear meters of opening height _____

Wall cavity thickness _____

The estimator will need to take the total lineal footage of the building and add 0.61 m for each inside 90° corner and 0.31 m for each inside 45° corner on the footprint.

INSTALLATION MANUAL

This chart enables an estimator working in metric dimensions to easily summarize the necessary information regarding total opening width and height for estimating rough buck material along with the total m² of openings there are in the building. These totals will be used in estimating formulas further on in this section.

METRIC DIMENSION OPENINGS SUMMARY CHART				
OPENING #	QUANTITY	X WIDTH	X HEIGHT	= TOTAL m ²
TOTALS				

TO CALCULATE THE STANDARD FORM UNITS:

- Gross Wall Area (m²) = Total Linear footage of wall (m) x Total Height (m)
- Net Wall Area (m²) = Gross Wall Area (m²) – Total area of openings (m²)
- Total Standards/course = (Total Lineal meters of wall – (# 90° Corners x 4) – (# 45° Corners x 3)) ÷ 2.44
- Total Standards before deductions = Total Standards/course x # of courses

If brick ledge or taper top are needed for the building they need to be subtracted off the total standards calculated above.

- Standards (BL) = Lineal meters of Brick Ledge ÷ 2.44
- Standards (TT) = Lineal meters of Taper Top ÷ 2.44
- Standards (OP) = ((LMOP x # COP) ÷ 1.219) ÷ 3
- Total Standards = Total Standards before deductions - Standards (BL) - Standards (TT)

TO CALCULATE THE NUMBER OF 90° CORNER FORMS:

$$90^\circ \text{ form} = \#90 \times \#C$$

This formula multiplies the number of 90° corners by the number of courses.

TO CALCULATE THE NUMBER OF 45° CORNER FORMS:

$$45^\circ \text{ form} = \#45 \times \#C$$

This formula multiplies the number of 45° angles by the number of courses.

TO CALCULATE THE NUMBER OF BRICK LEDGE FORMS:

$$\text{BLF} = \text{LDBLF} \div 2.44 \text{ or } \text{BLF8} = \text{LDBLF} \div 1.22$$

This formula divides the linear footage of brick ledge form units by 1.22 or 2.44. Brick Ledge forms are available in 2 lengths; 2.44m lengths are available from Nudura's Canadian plant and the 1.22m lengths are available from the US plant. Note: Additional brick ledge form units may be required for corners.

TO CALCULATE THE NUMBER OF BRICK LEDGE EXTENSIONS:

$$\begin{aligned} \text{BLE} &= \text{LDBLE} \div 0.8128 \\ \# \text{ of Screws} &= \text{BLE} \times 6 \end{aligned}$$

This formula divides the linear meters of brick ledge extension by 0.8128. Note: Additional brick ledge extension may be required for corners.

TO CALCULATE THE NUMBER OF OPTIMIZER FORMS:

$$\begin{aligned} \text{OP} &= (\text{LMOP} \times 2 \times \# \text{COP}) \div 1.219 \\ \text{OPTIES} &= (\text{OP} \div 2) \times 6 \end{aligned}$$

This formula corrects the linear meters of perimeter of Optimizer required, divides by 4, multiplies by 2 and multiplies by the number of courses required.

TO CALCULATE THE NUMBER OF HEIGHT ADJUSTERS:

$$\begin{aligned} \text{HA} &= (\text{LDHA} \times \# \text{CHA} \times 2) \div 0.8128 \\ \text{HA Ties} &= (\text{HA} \div 2) \times 4 \end{aligned}$$

This formula divides the length of Height Adjuster (0.8128 m), and multiplies by the number of courses required

TO CALCULATE THE NUMBER OF ROLLS OF WATERPROOFING:

$$\text{WP} = \text{LMWP} \times \text{HWP} \div 19.5$$

A roll of waterproofing is 20.9 sq. m. but the wall coverage is 19.5 m². This allows for a 76 mm overlap at the edges of the membrane.

TO CALCULATE THE NUMBER OF BAGS OF PREPCOAT PARGING MIX:

$$\text{PC} = \text{LMPAR} \times \text{HPAR} \div 6.97$$

The surface area to be parged is divided by 6.97 m². This is the average coverage obtained per bag for a two coat application. (Base & Finish Coats)

TO CALCULATE THE NUMBER OF FIBER MESH ROLLS:

$$\text{FM} = \text{LMPAR} \times \text{HPAR} \div 44.1$$

A roll of fiber mesh is 44.1 sq. m. An allowance for overlap may be required depending on the application techniques.

TO CALCULATE THE QUANTITY OF WALL ALIGNMENT SYSTEM:

$$\text{WAS} = \text{LDPER} + 1 \text{ per corner and T intersections} \div 1.63$$

The formula allows for one unit every 1.63 m plus an additional unit for every corner and T wall connection. Should a site have numerous openings with center of opening less than 1.63 m apart, the quantity of WAS may need to be increased.

INSTALLATION MANUAL

TO CALCULATE THE AMOUNT OF REBAR:

How to Determine the Required Reinforcing Steel to Wall Area "Ratio"

The ratios shown in Table 2.2.2.1 have been calculated by totaling the bar length specified for each scenario then dividing this length by the total square footage of wall area that encompasses these bars. Using this method, a ratio can be specified for both vertical and horizontal mats of steel separately (if they are different diameters from each other) Or if both mats are the same diameter of steel, the ratio can be specified as a "Combined Steel Mat".

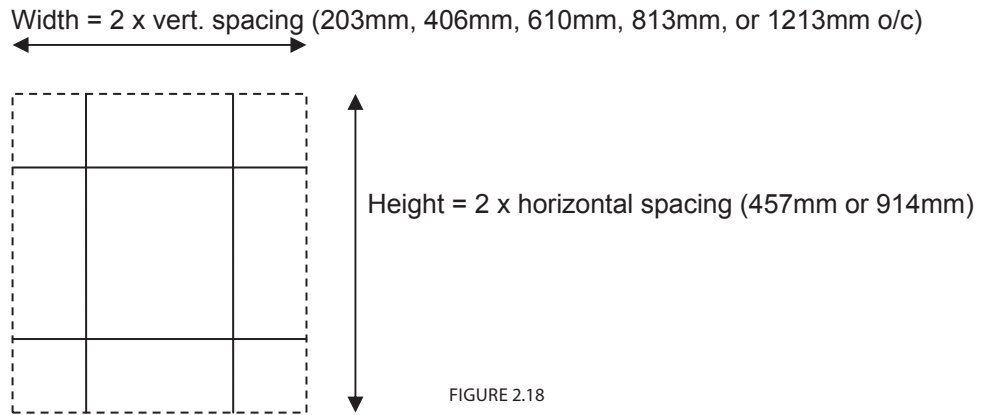

Table 2.2.2.1

	Vert. o/c Spacing (mm)	Horiz. o/c Spacing (mm)	Ratio LM/SM of Wall Single Mat	Ratio LM/SM of Wall Double Mat
Vertical Only Steel Mat	203	-	4.92	9.84
	406	-	2.46	4.92
	610	-	1.64	3.28
	813	-	1.25	2.50
	1213	-	0.82	1.64
Horizontal Only Steel Mat	-	457	1.08	2.16
	-	914	7.12	14.24
Combined Steel Mat	203	457	5.48	10.96
	203	914	4.36	8.72
	406	457	3.84	7.68
	406	914	2.72	5.44
	610	457	3.41	6.82
	610	914	2.33	4.66
	813	457	3.02	6.04
	813	914	1.90	3.80
	1219	457	4.92	9.84
	1219	914	3.28	6.56

REBAR = LMPER x HW x MULTIPLIER (Table 2.2.2.1)

The linear meter of the wall is multiplied by both the height of the wall and by value obtained in Table 2.2.2.1 which is a constant. The result is in meters. This constant is for a rebar grid in the wall 0.457m x 0.406m horizontally and vertically respectively with an allowance for horizontal splices.

TO CALCULATE THE VOLUME OF CONCRETE:

$$\text{m}^3 \text{ of CONCRETE} = \text{LMPER} \times \text{HW} \times \text{Concrete Multiplier (Table 2.2.2.2)}$$

The concrete multipliers shown in Table 2.2.2.2 (below) are constants, each of which represent the total volume of concrete (in cubic yards) that is necessary to cover 1 square meter of wall area for the specified core thickness of form. To calculate the amount of concrete required to fill the wall, simply multiply the total area of the wall (in square meters) by the multiplier shown for the selected core thickness of form. The volume of concrete ordered should be reduced in accordance with window and door openings. If using a concrete pump as a method of placement, an allowance must be included within the calculated volume of concrete to account for waste. Nudura recommends an additional concrete volume of 1 m³ to 2 m³ for the pump unit.

Table 2.2.2.2

CONCRETE CORE SIZE	CONCRETE MULTIPLIER
102 mm	0.102
152 mm	0.152
203 mm	0.203
254 mm	0.254
305 mm	0.305

TO CALCULATE THE NUMBER OF VERTICAL JOINT CLIPS:

$$\text{VJC} = (\text{LPPER} \div 2.44\text{m} \times 4 \text{ per standard} \times \# \text{ of courses}) + (\# \text{ of Corners} \times 4 \times \# \text{ of courses})$$

The VJC formula takes the lineal footage of the perimeter of the structure and divides by the length of a standard form. Then multiply this by 4 per standard form and then multiply again by the number of courses. The second part of this formula then takes the number of corners and multiplies by 4 clips per corner and then multiplies by the number of courses.

Note: Remember that what is in the brackets must be completed before adding them together for the total number of clips.

INSTALLATION MANUAL

ESTIMATING FORMULAE SUMMARY (METRIC)

STANDARD FORM UNITS:

Gross Wall Area (m²) = Total Linear footage of wall (m) x Total Height (m)

Net Wall Area (m²) = Gross Wall Area (m²) – Total area of openings (m²)

Total Standards/course = (Total Lineal meters of wall – (# 90° Corners x 4) – (# 45° Corners x 3)) ÷ 2.44

Total Standards before deductions = Total Standards/course x # of courses

Standards (BL) = Lineal meters of Brick Ledge ÷ 2.44

Standards (TT) = Lineal meters of Taper Top ÷ 2.44

Standards (OP) = ((LMOP x # COP) ÷ 1.219) ÷ 3

TOTAL STANDARDS = Total Standards before deductions - Standards (BL) - Standards (TT)

90° FORM UNIT: 90° FORM = #90 x #C

45° FORM UNIT: 45° FORM = #45 x #C

BRICK LEDGE FORM 1.22m UNIT: BLF = LMBLF ÷ 1.22

BRICK LEDGE FORM 2.44m UNIT: BLF = LMBLF ÷ 2.44

BRICK LEDGE EXTENSION: BLE = LMBLE x .375
of Screws = BLE x 6

OPTIMIZER FORM UNIT: OP = (LMOP x # COP) ÷ 1.219
OP Ties = OP x 6

HEIGHT ADJUSTER: HA = LMPER x .75 x #CHA
HA Ties = (HA ÷ 2) x 4

WATERPROOFING: WP = LMWP x HWP ÷ 19.5

PARGING COAT: PC = LMPAR x HPAR ÷ 6.97

FIBER MESH: FM = LMPAR x HPAR ÷ 44.1

WALL ALIGNMENT SYSTEMS: WAS = LMPER + 1 per corner or tees ÷ 1.63

REBAR: REBAR = LMPER x HW x MULTIPLIER (Table 2.2.2.1)

CONCRETE: Concrete = LMPER x HW x Concrete Multiplier (Table 2.2.2.2)

VERTICAL JOINT CLIPS: VJC = (LPPER ÷ 2.44m x 4 x #C) + (# of Corners x 4 x #C)

ESTIMATING RADIUS WALLS (METRIC)

For determining total number of radius forms required for on site construction of a Nudura radius wall or for preparing an order for factory cut Nudura radius forms, you can use the calculation formula below. This formula assumes that any radius constructed will be an “arc length segment” of a full circle with a known angle of rotation:

The following information is required to determine total number of radius forms for any given radius wall in a floor plan:

1. The Outside radius (measured in millimeters) from the focus point to the outside face of the NUDURA form
2. The inside radius (equals the Outside radius (in millimeters) less the total form thickness being used)
3. The Degrees of Turn of radius (this is total number of degrees of rotation that the radius covers of a full circle)
4. The Total Wall Height (measured in millimeters).

TO CALCULATE THE TOTAL NUMBER OF RADIUS FORMS REQUIRED:

No. of forms per course		No. of courses
No. of Forms = Outside radius (in mm) x 6.283 x (Degrees of Turn of Radius/360)	X	Wall Height (in mm)
2438		457





NOTES:



1. To assure adequate product for accommodating custom fitting of the wall forms into the standard elements of the plan, the first part of the calculation (no. of forms per course) above should be **ROUNDED** up to a whole number or (full form length) before multiplying by the number of courses of forms required.
2. Do NOT deduct any allowance for openings particularly if placing orders at the factory for custom radius forms.

As an alternate, you can also obtain NUDURA’s radius wall form unit spread sheet calculator through your distributor which enables the same calculation to be performed in Microsoft excel® along with giving the required cut segment lengths. (The distributor can also duplicate the quantity portion of this calculator by entering data into the NUDURA radius wall digital order form).

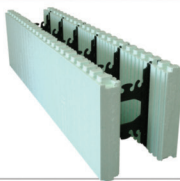
Further guidance on estimating for Nudura radius walls is available through your Nudura distributor Or can be downloaded directly from the Construction Professional Section of Nudura’s Website under “Technical Bulletins and Guides”.

2.2.3 FORM UNIT CONCRETE VOLUMES

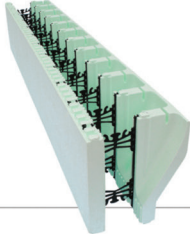
		Core Thickness	Imperial Measurement	Metric Measurement	
	Standard Form Unit	Wall Coverage	n/a	12 ft ²	1.11 m ²
	Nom. Weight	n/a	16.10 lb	7.30 kg	
	Concrete Volume	4" (100 mm)	0.157 yd ³	0.120 m ³	
		6" (150 mm)	0.231 yd ³	0.177 m ³	
		8" (200 mm)	0.306 yd ³	0.234 m ³	
		10" (250 mm)	0.380 yd ³	0.290 m ³	
12" (300 mm)	0.454 yd ³	0.347 m ³			
	90° Form Unit	Wall Coverage	n/a	6.0ft ²	0.560 m ²
	Nom. Weight	n/a	6.00 lb	2.72 kg	
	Concrete Volume	4" (100 mm)	0.063 yd ³	0.048 m ³	
		6" (150 mm)	0.088 yd ³	0.067 m ³	
		8" (200 mm)	0.122 yd ³	0.093 m ³	
		10" (250 mm)	0.159 yd ³	0.122 m ³	
12" (300 mm)	0.200 yd ³	0.153 m ³			
	45° Form Unit	Wall Coverage	n/a	4.6 ft ²	0.43 m ²
	Nom. Weight	n/a	5.70 lb	2.59 kg	
	Concrete Volume	4" (100 mm)	0.056 yd ³	0.043 m ³	
		6" (150 mm)	0.079 yd ³	0.060 m ³	
		8" (200 mm)	0.102 yd ³	0.078 m ³	
		10" (250 mm)	0.135 yd ³	0.103 m ³	
12" (300 mm)	0.180 yd ³	0.138 m ³			
	Optimizer Form Unit	Wall Coverage	n/a	4 ft ²	0.37 m ²
	Nom. Weight	n/a	5.36 lb	2.43 kg	
	Concrete Volume	6" (150 mm)	0.077 yd ³	0.059 m ³	
		8" (200 mm)	0.102 yd ³	0.078 m ³	
		10" (250 mm)	0.126 yd ³	0.096 m ³	
12" (300 mm)		0.151 yd ³	0.115 m ³		
	Height Adjuster	Wall Coverage	n/a	0.667 ft ²	0.062 m ²
	Nom. Weight	n/a	0.83 lb	0.38 kg	
	Concrete Volume	4" (100 mm)	0.009 yd ³	0.007 m ³	
		6" (150 mm)	0.013 yd ³	0.010 m ³	
		8" (200 mm)	0.017 yd ³	0.013 m ³	
		10" (250 mm)	0.021 yd ³	0.016 m ³	
12" (300 mm)	0.025 yd ³	0.019 m ³			

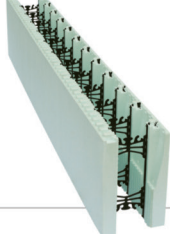
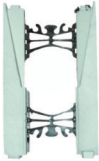
		Core Thickness	Imperial Measurement	Metric Measurement	
	Brick Ledge Form Unit	Wall Coverage	n/a	12 ft ²	1.11 m ²
	Nom. Weight	n/a	16.50 lb	7.48 kg	
	Concrete Volume	4" (100 mm)	0.251 yd ³	0.192 m ³	
		6" (150 mm)	0.325 yd ³	0.248 m ³	
		8" (200 mm)	0.399 yd ³	0.305 m ³	
		10" (250 mm)	0.474 yd ³	0.362 m ³	
		12" (300 mm)	0.548 yd ³	0.419 m ³	
	Brick Ledge Extension	Wall Coverage	n/a	2.889 ft ²	0.268 m ²
	Nom. Weight	n/a	1.01 lb	0.46 kg	
	Concrete Volume	n/a	0.014 yd ³	0.011 m ³	
	Taper Top Form Unit	Wall Coverage	n/a	12 ft ²	1.11 m ²
	Nom. Weight	n/a	15.37 lb	6.97 kg	
	Concrete Volume	4" (100 mm)	0.182 yd ³	0.139 m ³	
		6" (150 mm)	0.256 yd ³	0.196 m ³	
		8" (200 mm)	0.330 yd ³	0.252 m ³	
		10" (250 mm)	0.404 yd ³	0.309 m ³	
		12" (300 mm)	0.478 yd ³	0.365 m ³	
	Double Sided Taper Top	Wall Coverage	n/a	12 ft ²	1.11 m ²
	Nom. Weight	n/a	14.43 lb	6.55 kg	
	Concrete Volume	4" (100 mm)	0.206 yd ³	0.157 m ³	
		6" (150 mm)	0.280 yd ³	0.214 m ³	
		8" (200 mm)	0.354 yd ³	0.271 m ³	
		10" (250 mm)	0.428 yd ³	0.327 m ³	
		12" (300 mm)	0.502 yd ³	0.384 m ³	

2.3 BUILDING PERMIT SUBMISSION REQUIREMENTS

If a Builder or Contractor is submitting for permit on a Nudura Building with custom stamped documentation that has been overseen by a professional engineer, normally permit submission to a Building Department can proceed with little delay. However, this section of the manual is intended to provide suggestions to the contractor who has never submitted for permit before using Nudura Integrated Building Technology. The suggestions provided here, as academic as they may be, will help a permit submission to go as smoothly as possible.

First: understand that the Building Official needs to be able to reference an enabling piece of legislation that ensures the engineering specifications for the building are provided for under local jurisdiction.



FIGURE 2.19

USA

The US National Code Agency “The international Code Council” is responsible for administering the 2003, 2006 and 2009 international residential Building Codes. The local municipality, dependant upon State, may have already adopted one of the three codes mentioned above or is well on its way to doing so. These codes contain prescriptive structural design tables for both below grade and above grade reinforcing steel requirements, as well as typical lintel designs tables. These tables are referenced within Nudura’s ICC-ES evaluation report (ESR-2092). A copy of this evaluation report can be downloaded from Nudura’s web site and should be submitted to the building department for permit approval.

CANADA

Since 2005, prescriptive structural design tables and scope of applicability limits are also have been provided under the Housing and Small Buildings section of the National Building Code (Part 9) and under Part 9 of the Ontario, Quebec, Alberta and British Columbia Building Codes.

In either case (USA or Canada) the design builder or contractor can ensure a much smoother permit submission and direct acceptance of the Building Official if the following guidelines are applied during plan submissions.

First, since the local Building Official may not have seen Nudura before, ensure that he or she has a copy of 2 important documents:

- (a) The Nudura Installation Manual
- (b) The applicable Nudura evaluation report or Intertek Product Certification Documentation for your region

USA - ICC-ES – ESR-2092

CAN - Intertek Certification Documentation to CAN/ULC S717.1 and its related documents

Europe - EOTA- Eta-07 0034

Other State, Provincial or Regional approvals may be required to be included with the permit submission to demonstrate the system’s compliance with these provisions as well. If you are unsure, check with your distributor. They can advise you on the additional documents that may be required for your specific region. These documents are summarized in the following section, (Section 2.4).

2.4 EVALUATION REPORTS AND APPROVALS

USA EVALUATIONS AND APPROVALS

National:	<ul style="list-style-type: none"> • Certified to: ASTM E 2634 • ICC-ES (AC-353) 	Intertek: SDID No. 21903 ESR-2092 (TYPES I-V/ N/C, A&C*)
State:	<ul style="list-style-type: none"> • State of Florida 	FL1585-R3
County/City:	<ul style="list-style-type: none"> • Miami Metro Dade • City of New York 	NOA 16-0627-01 Complies with OTCR 2009-020

**Approved for use in "Attics and Crawlspace" uncovered per report conditions*

CANADA EVALUATIONS AND APPROVALS

National:	<ul style="list-style-type: none"> • Certified to: CAN/ULC S717.1 	Intertek: SDID No. 21903
-----------	--	--------------------------

EUROPE EVALUATIONS AND APPROVALS

International:	<ul style="list-style-type: none"> • European Union of Technical Assesments (EOTA) Assessed in Compliance with EOTA: ETAG 009 • British Board of Agrément (BBA) ETA-07/0034 	
France:	<ul style="list-style-type: none"> • CSTB (Based on ETA 07/0034) • ACERMI Issuing Summer 2017 	DTA 16/09-581

MIDDLE EAST EVALUATIONS AND APPROVALS

United Arab Emirates:	<ul style="list-style-type: none"> • Certified to ASTM C78 • Dubai Central Laboratory: 	CL 16020326
-----------------------	--	-------------



2.5 BUILDING DEPARTMENT: TYPICAL EXPECTATIONS



FIGURE 2.20

Most building departments have put together a set of guidelines of necessary documentation that needs to be included with any submission to obtain a building permit. Without these documents, permit delays can occur costing time and money for any project. It is imperative that whoever is submitting for the building permit communicate with the building department and ask them for a list of required documentation. Remember that the building department cannot make assumptions about the building process as in many cases the building department can have a number of internal departments reviewing a set of plans.

Nudura has included here a list of potential documents that might be required for submission to a building department to gain a building permit for a building using the Nudura Form System.

Note: This list is only a guide and is not intended to override any existing requirements a building department might already have in place.

Completed set of working drawings

Floor Plans

- Show that Nudura ICF is being used by some means- either on the plans directly or notes outlining INTENTION to substitute the conventional construction method shown with Nudura.
- List the size and spacing of the vertical and horizontal reinforcing steel and make reference from where this was obtained.
- If beam pockets are needed, show location and reference any additional reinforcing steel necessary.

Elevations

Building Section Drawings

- Show floor to floor heights for each story
- Exterior Finishes
- Interior Finishes
- Backfill Heights
- Footing Sizes

Relevant Detail Section Drawings

- Include photocopies of any details from this manual
- Floor Connection Details
- Roof Connection Details

Don't forget to ensure that the drawing set has been produced to include the data outlined under Section 2.1 "Drawing and Contract Document Preparations". This will help the Building Official to understand all of the prescriptive elements being covered in the design and avoid any question both during plan examination and subsequent inspection on site.

And finally be sure to include copies of:

- The applicable evaluation report for the site
- Additional regional documentation as may be required
- Structural Table Data to corroborate design
- Lintel schedule, if produced separately

2.6 PRE CONSTRUCTION PLANNING

To ensure that the project is successful, it's important to start with a detailed plan of action before any work commences. Having a plan of execution is just as important as a detailed building plan, and this will help the contractor avoid costly delays in construction along with bringing the project in on budget. The following steps will ensure the project gets started on the right path to completion.

STEP 1: UNDERSTAND THE PROPERTY: identify the services that will need to be brought into the building. Determining the necessary services and the connection points, will allow the contractor to plan entry locations for penetrations going through the wall section.

Obtain all the necessary permits, and become familiar with the local by-laws and covenants for the area before construction. Remember that soil conditions and the lot elevations will have an effect on footing (footer) sizes and building elevation for the area. Water tables may also dictate the elevation of a building and it is recommended that a contractor check with local residents for any water issues in the area – particularly any seasonal flood issues that can assist in setting final elevation of the building OUT of potential water problems down the road. Matching the building elevation with property slopes will ensure proper drainage away from the building once construction is completed. It will also be beneficial to plan the building's finished elevation to meet surrounding properties and the finished elevations. Consulting a professional for site planning and drainage planning will ensure costly maintenance in the future can be avoided.



FIGURE 2.21

STEP 2: SITE PREPARATION: As with any construction site, heavy construction equipment is necessary for completion of the project. Nudura Integrated Building Technology is no different as there will be large delivery vehicles, heavy excavation equipment, and concrete trucks and pumps entering the property. All of these vehicles will require additional room to maneuver around the site to effectively perform the tasks needed to complete the project. Depending upon soil conditions, a solid sub base for the driveway will ensure the above mentioned pieces of equipment can maneuver around the site with ease. This will also help to compact the soil, which will limit settlement once the finished grade is determined. Also make sure that there is room for any pieces of equipment needing to swing booms into the structure without interference from electrical lines, neighboring dwellings, and any other dangerous obstructions.



FIGURE 2.22

Now that the above steps have been reviewed, the contractor has the necessary plan to move forward with construction of the building. These items need to be documented for site plan submission to the local building department and are an essential part of the package the home owner requires, keeping on file for future maintenance of the property.